



maxema®

Color League

MADE IN ITALY

PRODOTTO IN ITALIA







FABRIQUE EN ITALIE

FABBRICADO EN ITALIA

Indice

contents

Introduzione	06
Introduction	

Flow Pure	10
meccanismo a rotazione / twist-action	
F2 P – MATT B 	14
F2 P – MATT CB 	16
F2 P – MATT 	18
F2 P – MATT F 	20
F2 P – C 	22
F2 P – B 30 	24
F2 P – GOM K	26
F2 P – GOM CB	28
F2 P – GOM 30	30
F2 P – GOM CF	32
F2 P – GOM KF	33
F2 P – GOM 30 F	34

Flow	36
meccanismo a rotazione / twist-action	
F1 – BC CR	40
F1 – B 30 CR	42
F1 – C CR	44
F1 – 30 CR	46
F1 T – GOM C CR	48
F1 T – GOM CB CR	50
F1 T – GOM 30 CR	52

Dot	54
meccanismo a scatto / retractable	
D1 – B CR	58
D1 – BC CR	60
D1 – B 30 CR	62
D1 – CB CR	64
D1 – C CR	66
D1 – 30 CR	68
D1 – GOM K 	70
D1 – GOM CB CR	72
D1 – GOM C CR	74
D1 – GOM 30 CR	76
D1 – C GOLD	78
D1 – GOM CB F CR	79
D1 – GOM KF CR	80
D1 – GOM 30 F CR	81

Zink	82
meccanismo a rotazione / twist-action	
Z1 – C	86
Z1 – B 30	88
Z1 – 30	90
Z1 – CF	92

View	94
meccanismo a rotazione / twist-action	
V1 – C CR / V1 – C CR T	98
V1 – 30 CR / V1 – 30 CR T	100
V1 – AL CR / V1 – AL CR T	101
V1 – GOM C CR /	102
V1 – GOM C CR T	

Tag	104
meccanismo a rotazione / twist-action	
TA1 – MATT AL B	108
TA1 – B CR	110
TA1 – CB CR	111
TA1 – MATT AL	112
TA1 – FROST AL	113
TA1 – C CR	114
TA1 – 30 CR	116
TA1 – GOM C CR	117
TA1 – MET AL	118
TA1 – AL CR	119

Icon	120
meccanismo a rotazione / twist-action	
IC400 – C	124
IC400 – MATT	125
IC400 – 30	126
IC400 – FROST	127
IC400 – MATT AL	128
IC400 – C CR	130
IC400 – FROST AL	132
IC400 – 30 CR	133
IC400 – C GOLD	134
IC400 – MET AL	135
IC400 – AL CR	135

Tag green	136
meccanismo a rotazione / twist-action	
TA2 – B	142
TA2 – BC	143

Icon green	144
meccanismo a rotazione / twist-action	
IG2 – BC	150
IG2 – C	151

Ethic	152
meccanismo a rotazione / twist-action	
ET900 – MULTICOLOUR	156
ET900 – FLAG	157
ET900 – C FLAG	157
ET900 – B	158
ET900 – BC	159
ET900 – C CR	160
ET900 – C GOLD	161
ET900 – AL	162
ET900 – AL CR	163
ET900 – AL FLAG	163
ET900 – MET CR	164
ET900 – MET AL	165

Next	166
meccanismo a scatto / retractable	
NX400 – C CR	170
NX400 – 30 CR	171
NX400 – FROST AL	172
NX400 – MET AL	173
NX400 – AL CR	173
NX400 – GOM C CR	174
NX400 – GOM AL	175

Pixel	176
meccanismo a scatto / retractable	
PX40 – B	180
PX40 – C	181
PX40 – MATT CB 	182
PX40 – MATT CR	184
PX40 – B 30	186
PX40 – 30	187
PX40 – FROST NEUTRAL	188
PX40 – FROST	189
PX40 – GOM C CR	190
PX40 – GOM 30 CR	191

Bay	192
meccanismo a rotazione / twist-action	
B500 – MATT BC	196
B500 – MATT	198
B500 – BC	200
B500 – C	201
B500 – 30	202
B500 – FROST	203

Soft	204
meccanismo a rotazione / twist-action	
S90 – B	208
S90 – B 30	209
S90 – 30	210
S90 – AL 30	211

Polo	212
meccanismo a scatto / retractable	
P600 – B	216
P600 – C	217
P600 – C AL	218
P600 – 30 AL	219
Packaging 	220
supporti di vendita 	222
sales support	
palette colori	232
colour palette	
codici pantone	233
pantone codes	
inchiostri e refill	234
inks and refills	



Maxema

solo una penna?
Maxema, just a pen?

Progettazione

Planning

IT Non tutti sanno che per costruire una penna curata in ogni dettaglio può essere necessario anche più di un anno di lavoro. Costruire lo stampo per ogni componente di una penna è un'operazione molto complessa: anche l'errore di un centesimo di millimetro può comprometterne la funzionalità. Ecco perché la progettazione e la produzione delle nostre penne avviene interamente nella nostra unica sede italiana, dove possiamo controllare ogni passaggio: dai primi prototipi fino alla commercializzazione del prodotto definitivo.

EN Not everyone knows that it can take more than a year to create a new pen in which every detail is handled with meticulous care. Creating the moulds for each component of the pen is a highly complex operation: a mistake of even a hundredth of a millimetre could jeopardise its operation. This is why all our pens are designed and manufactured entirely in our only Italian premises, where we are able to monitor every stage: from the first prototypes right down to marketing the finished product.

Design

Design

IT Il design delle nostre penne è frutto di costanti ricerche stilistiche: le linee e i colori si ispirano alle tendenze del momento. Una penna promozionale deve attrarre ed emozionare, oltre che essere un supporto di qualità per il messaggio che le viene affidato. Estetica, originalità, qualità: tutto deve essere perfettamente equilibrato per rendere una penna degna di sposarsi ad un'immagine aziendale unica e speciale.

EN The design of our pens is the outcome of ongoing styling research: the lines and colours are inspired by the trends of the day. A promotional pen must attract and excite, as well as being a quality support for the message it is delegated to convey. Appearance, originality, quality: everything must be perfectly balanced to make a pen worthy to carry a uniquely special company image.

Qualità

Quality

IT La cura della qualità comincia dalla severa selezione delle materie prime: la plastica, i refill e le molle interne provengono esclusivamente da fornitori italiani o tedeschi, che possono garantirne la qualità e l'affidabilità. La plastica è ottenuta con ABS di prima qualità, atossico, altamente resistente ad urti e sbalzi termici, garanzia di eccellente lucentezza e stabilità del colore. I refill sono conformi alle Direttive della Comunità Europea in materia di sostanze pericolose (2004/73/EC, 67/548/EEC, 2006/1907/EC-REACH) e al TSCA (Toxic Substances Control Act) americano, in quanto contengono inchiostri atossici.

EN Attention to quality starts with the strict selection of raw materials: the plastic, refills and inner springs come exclusively from Italian or German suppliers, who guarantee their quality and reliability. The plastic for our pens comes from top quality, non-toxic ABS, which is highly resistant to knocks and sudden changes in temperature, guaranteeing excellent glossiness and high colour stability. The refills respect EU Directives for hazardous substances (2004/73/EC, 67/548/EEC and 2006/1907/EC-REACH) and the American TSCA (Toxic Substances Control Act): so all the inks are non-toxic.

Produzione

Production

IT Le nostre linee di montaggio ad elevata automazione assicurano tempi di produzione rapidi e altamente competitivi: a seconda del modello, i macchinari possono montare da 2.000 a 6.000 pezzi l'ora. Automazione significa anche garanzia di funzionalità: rigorosi controlli qualitativi verificano ad ogni fase del montaggio il perfetto funzionamento di ogni penna.

EN Our highly automated assembly lines guarantee rapid, extremely competitive manufacturing times: depending on the model, our machinery can assemble from 2,000 to 6,000 pcs per hour. Automation also means guaranteeing functionality: strict quality checks make sure that all our pens operate perfectly at each stage of their assembly.

Sostenibilità

Sustainability

IT Solo una penna di qualità valorizza ogni messaggio, aumenta la visibilità di un marchio e contribuisce a limitare l'inquinamento del pianeta. La plastica inquina: se una penna è di qualità, avrà una vita mediamente lunga che la porterà a passare più volte di mano in mano, contenendo gli sprechi che derivano dall'immediata eliminazione di penne difettose. Meglio investire in penne di qualità, magari riducendone la quantità, piuttosto che rischiare di compromettere la propria immagine e diffondere un uso poco responsabile delle penne in plastica. Più lunga è la vita di una penna, meno si inquina l'ambiente.

EN Only a quality pen can really enhance a message, growing a brand's visibility and, why not, helping to limit the pollution of the planet. Plastics pollute: if a pen is high quality it will have a long average lifespan that will lead it to change hands more than once, so limiting the waste that comes from the immediate discarding of faulty pens. It is much better to invest in quality pens, maybe choosing to limit the quantity rather than running the risk of compromising your image and spreading the irresponsible use of plastic pens. The longer a pen's life is, the less it pollutes the environment.

Personalizzazione

Customisation

IT Una volta montata, la penna è pronta per essere "vestita" con un marchio o un messaggio: il nostro studio grafico elabora simulazioni digitali per valutare le possibili alternative e suggerisce nuove proposte per arrivare all'abbinamento più adatto. Proprio come in una sartoria si provano misure, colori e posizioni diverse finché l'abito si adatta perfettamente alle forme del cliente. Solo allora comincia la fase di stampa, tampografica o serigrafica, che avviene con l'utilizzo di vernici ad alta tenuta, al termine della quale la penna è finalmente pronta per portare il suo messaggio prezioso: la vostra immagine.

EN Once assembled, the pen is ready to be "dressed" with a logo or a message: our graphics office works on digital simulations to assess the possible alternatives, suggesting new proposals so that the most suitable combination can be found. Like a tailor's shop, the customer can try different sizes, colours and positions until the suit adapts perfectly to his needs. Only then does the pad or silk-screen printing stage begin, using highly resistant paints, after which the pen is finally ready to travel the world with its precious message: your image.

Responsabilità

Responsibility

IT La certificazione di provenienza esclusivamente italiana garantisce che i nostri articoli da scrittura non provengano da sfruttamento di manodopera minorile o da condizioni lavorative in contrasto con il rispetto dei diritti fondamentali dei lavoratori. Chiediamo la stessa garanzia anche ai nostri fornitori italiani e tedeschi di materie prime. Anche la scelta di una penna può contribuire a diffondere la cultura e il rispetto della dignità dei lavoratori.

EN The certificate of origin for our pens also guarantees that no child labour is involved in their manufacture, nor working conditions that do not respect workers' basic rights. We demand the same guarantee from our Italian and German raw materials suppliers. Even a pen can help to spread the culture and respect of the dignity of workers.

Flow Pure

pura ed essenziale
free from extra



**L'essenza
del design.**

The essence of design.

Flow Pure

informazioni
tecniche

*technical
information*

Tampografia e serigrafia disponibili anche su fusto gommato.

*Pad and screen printing also
available on rubberised barrel.*

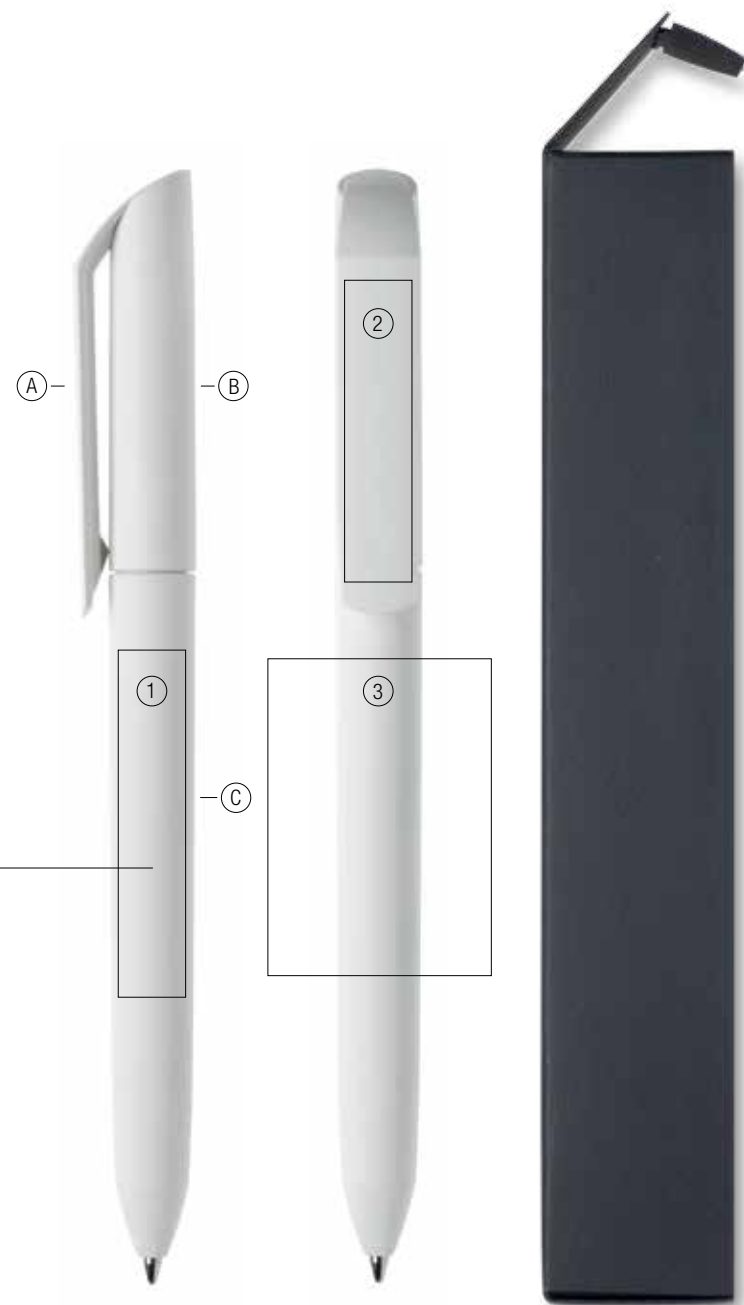

NEW

MY BOX

Astuccio universale
richiudibile per
penna singola
in cartoncino nero
Fedrigoni.
Info pag. 221

Universal reclosable
single pen
box in Fedrigoni
black card.
Info at p. 221

È possibile combinare particolari di colori diversi della stessa versione (o codice), oppure abbinare elementi di versioni differenti.

You can combine differently coloured parts from the same version (or code number), or elements from different versions.

- A** clip
- B** cappuccio
- C** fusto
- A** clip
- B** cap
- C** barrel

1/5

CARATTERISTICHE

- meccanismo a rotazione
- realizzata in plastica ABS, atossica e ad alta resistenza
- refill Jumbo, inchiostro blu e nero
- disponibile con superfici lucide, satinare o gommate

2/5

AREA STAMPABILE

- 1 tampografia 50 x 9 mm
- 2 tampografia 40 x 9 mm
- 3 serigrafia 45 x 30 mm

3/5

FUSTO E CAPPUCCIO

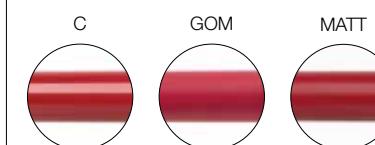

4/5

CLIP

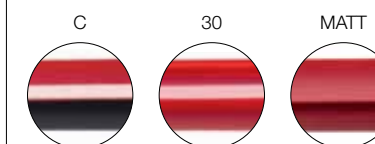

5/5

COLORAZIONI

- coprenti



- trasparenti



- fluo coprenti



- fluo trasparenti



FEATURES

- twist-action
- made of non-toxic highly resistant ABS plastic
- Jumbo refill, blue and black ink
- available in glossy, matt or rubberised finish

PRINT AREA

- 1 pad printing 50 x 9 mm
- 2 pad printing 40 x 9 mm
- 3 screen printing 45 x 30 mm

BARREL AND CAP

CLIP

COLOURS

- solid



- transparent



- solid fluo

- transparent fluo

Flow Pure F2 P – MATT B

fusto e cappuccio in colore bianco coprente,
clip in colore coprente, finiture satinare
solid white colour barrel and cap,
solid colour clip, matt finishes

NEW



15 rosso / tampografia 40 x 9 mm
15 red / pad printing 40 x 9 mm
—
tampografia 50 x 9 mm
pad printing 50 x 9 mm



**Satinata ed elegante: è la
nuova finitura matt su fusto,
cappuccio e clip.**

*Satin finish and elegant: this is the new
matt finish on barrel, cap and clip.*

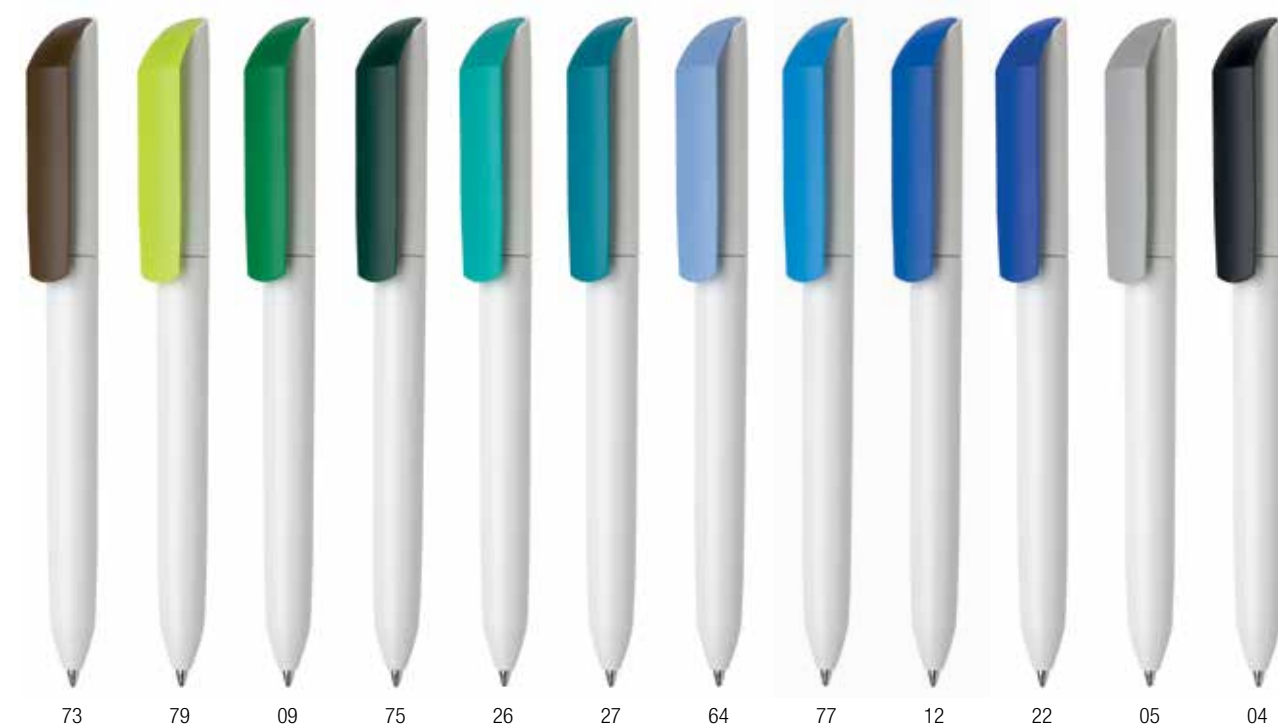

Flow Pure F2 P – MATT CB

fusto e cappuccio in colore coprente,
clip in colore bianco coprente, finiture satinare
solid colour barrel and cap, solid white
colour clip, matt finishes

NEW

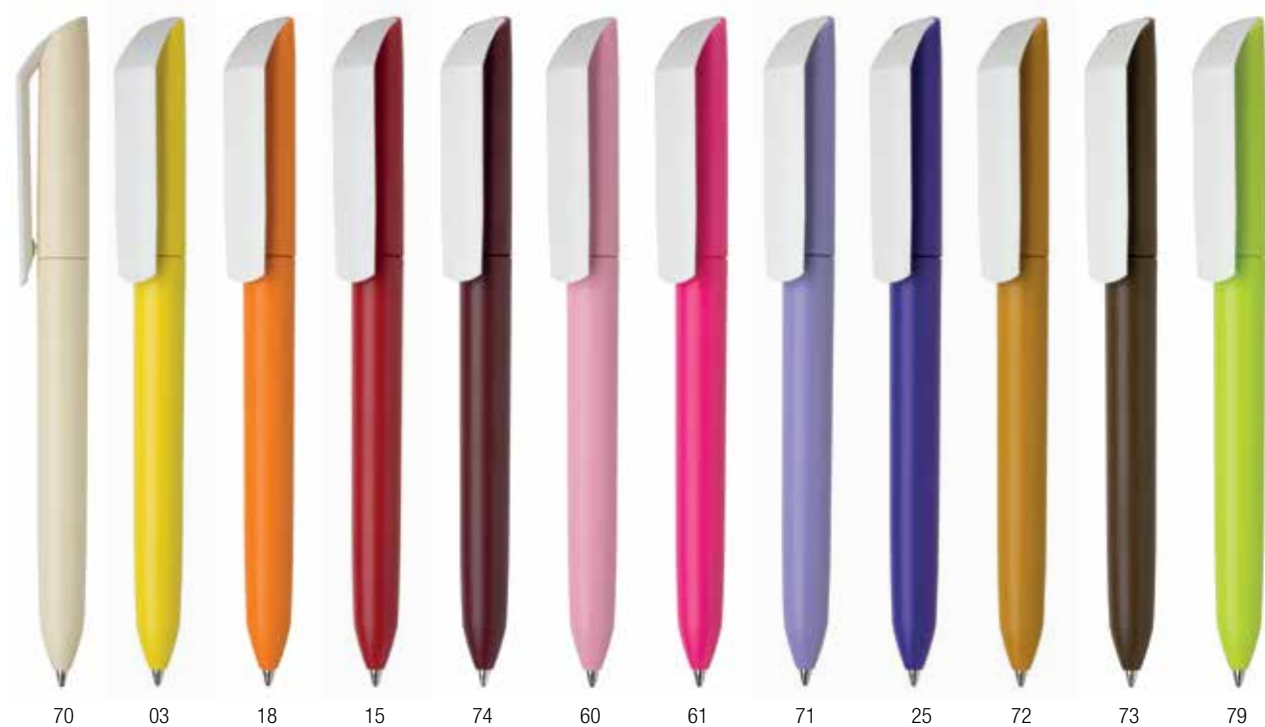

Finitura matt e clip bianca per la massima libertà di personalizzazione.

*Matt finish and white clip for maximum
freedom of personalisation.*

tampografia 40 x 9 mm
pad printing 40 x 9 mm

—
05 grigio / tampografia 50 x 9 mm
05 grey / pad printing 50 x 9 mm



Flow Pure F2 P – MATT

colori coprenti con finitura satinata
solid colours with matt finish

NEW



71 viola chiaro / tampografia 40 x 9 mm
71 light violet / pad printing 40 x 9 mm



Tutta la forza espressiva del colore in versione monocromatica.

*All the expressive force of colour
in a monochrome version.*

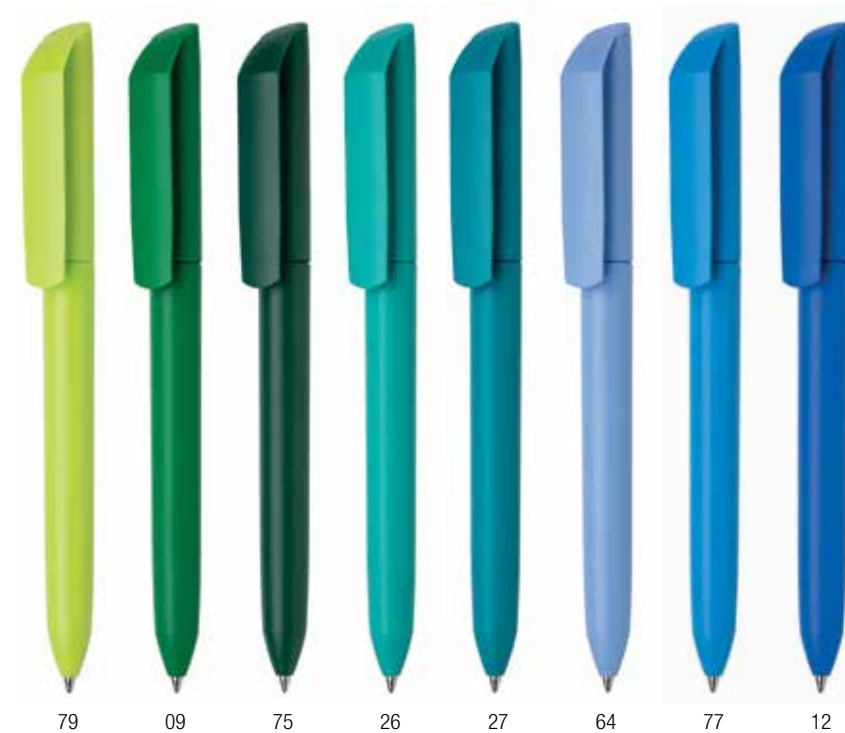

22 blu / tampografia 40 x 9 mm
22 blue / pad printing 40 x 9 mm



Flow Pure F2 P – MATT F

colori fluo coprenti con finitura satinata
solid fluo colours with matt finish

NEW

**fluo
colours**



02



14

17 arancio / tampografia 40 x 9 mm
17 orange / pad printing 40 x 9 mm

**fluo
colours**

**La finitura satinata
si accende
con i colori fluo.**

*The matt finish lights up with
fluo colours.*

56 fucsia / tampografia 40 x 9 mm
56 fuchsia / pad printing 40 x 9 mm



08

Flow Pure F2 P – C

colori coprenti con finitura lucida
solid colours with glossy finish

NEW

VICTORIA'S SECRET



**Il design è valorizzato
dalla versione monocromatica
e i colori risaltano grazie alla
brillantezza della finitura lucida.**

*The design is enhanced by the monochrome
version and the colours stand out due to the **brilliance**
of the gloss finish.*

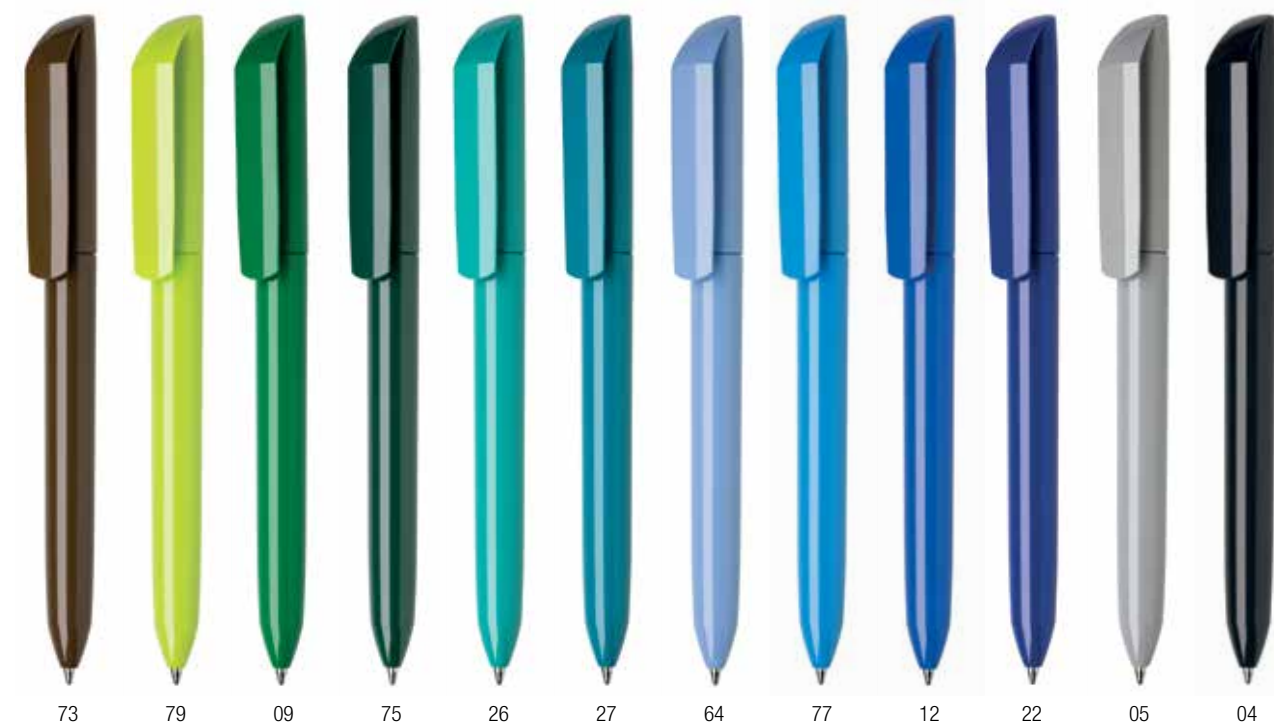

60 rosa / tampografia 40 x 9 mm
60 pink / pad printing 40 x 9 mm

Flow Pure

F2 P – B 30

fusto e cappuccio in colore bianco coprente,
clip in colore trasparente, finiture lucide
solid white colour barrel and cap, transparent
colour clip, glossy finishes

NEW



51 viola / tampografia 40 x 9 mm
51 violet / pad printing 40 x 9 mm



**Qualità e lucentezza
delle superfici catturano
l'attenzione con colori brillanti
e particolari trasparenti.**

*Surface quality and gloss capture the attention
with brilliant colours and transparent details.*

78 lime / tampografia 40 x 9 mm
78 lime / pad printing 40 x 9 mm



Flow Pure F2 P – GOM K

fusto e cappuccio in colore nero gommato,
clip in colore coprente lucido
black barrel and cap with rubber finish,
solid colour clip with glossy finish



70 crema / tampografia 40 x 9 mm
70 cream / pad printing 40 x 9 mm



03



18 arancio / tampografia 40 x 9 mm
18 orange / pad printing 40 x 9 mm



15



60



61



71



72



79



09



26 acquamarina / tampografia 40 x 9 mm
26 aquamarine / pad printing 40 x 9 mm



27



64



77



12



05



04

**Il nero è il nuovo
protagonista, in abbinamento
con i colori coprenti.**

*Black in combination with solid
colours is the new highlight.*

Flow Pure

F2 P – GOM CB

fusto e cappuccio in colore coprente gommato,
clip in colore bianco lucido
solid colour barrel and cap with rubber finish,
solid white colour clip with glossy finish

71 viola chiaro / tampografia 40 x 9 mm
71 light violet / pad printing 40 x 9 mm



Gommatura integrale:
fusto e cappuccio soft touch.

Rubberised all over:
soft touch barrel and cap.

04 nero / tampografia 40 x 9 mm
04 black / pad printing 40 x 9 mm

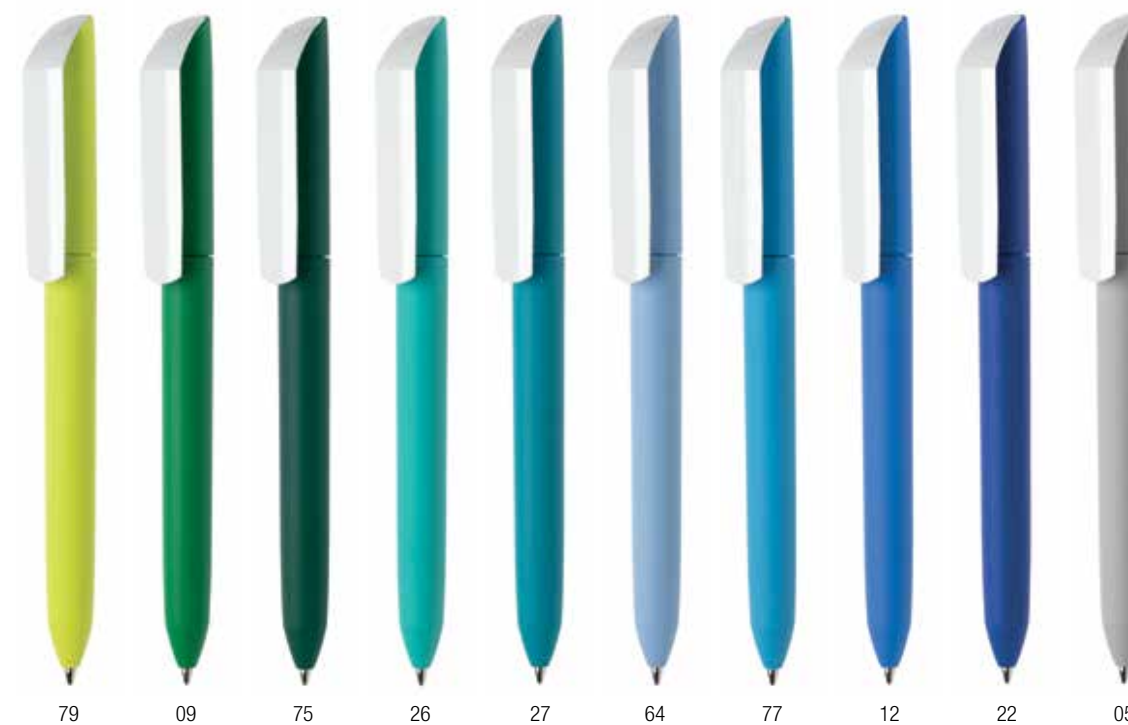

60 rosa / tampografia 40 x 9 mm
60 pink / pad printing 40 x 9 mm

Flow Pure F2 P – GOM 30

fusto e cappuccio in colore coprente gommato,
clip in colore trasparente lucido
solid colour barrel and cap with rubber finish,
transparent colour clip with glossy finish

38 marrone / tampografia 40 x 9 mm
38 brown / pad printing 40 x 9 mm



**Anche il fusto
è stampabile
con tampografia
o serigrafia!**

*Even the rubberised barrel
can be pad or silk-screen printed!*

50 grigio scuro / tampografia 40 x 9 mm
50 dark grey / pad printing 40 x 9 mm



49 verde / tampografia 50 x 9 mm
49 green / pad printing 50 x 9 mm



Flow Pure F2 P – GOM CF

fusto e cappuccio in colore fluo gommato,
clip in colore fluo coprente lucido
solid fluo colour barrel and cap with rubber finish,
solid fluo colour clip with glossy finish

**fluo
colours**



56 fucsia / tampografia 40 x 9 mm
56 fuchsia / pad printing 40 x 9 mm



08



02



17



14

Flow Pure F2 P – GOM KF

fusto e cappuccio in colore nero gommato,
clip in colore fluo coprente lucido
black barrel and cap with rubber finish,
solid fluo colour clip with glossy finish

**fluo
colours**



02 giallo / tampografia 40 x 9 mm
02 yellow / pad printing 40 x 9 mm



17



14 rosso corallo / tampografia 40 x 9 mm
14 coral red / pad printing 40 x 9 mm



56



08

Flow Pure F2 P – GOM 30 F

fusto e cappuccio in colore fluo gommato,
clip in colore fluo trasparente lucido
solid fluo colour barrel and cap with rubber finish,
transparent fluo colour clip with glossy finish

**fluo
colours**



20



33 arancio / tampografia 40 x 9 mm
33 orange / pad printing 40 x 9 mm



24



46



NEW

MY CASE

Astuccio universale
per penna singola
in cartoncino nero
Fedrigoni.
Info pag. 220

Universal single
pen box in Fedrigoni
black card.
Info at p. 220



48 verde / tampografia 40 x 9 mm
48 green / pad printing 40 x 9 mm

Profilo minimal e volumi compatti.

*Minimal profile
and compact volumes.*

Flow

senti il cambiamento
feel the change



**L'evoluzione
della forma,
con e senza texture.**

*Evolution of shape,
with and without texturing.*

Flow

informazioni
tecniche

*technical
information*

**Tampografia
e serigrafia
disponibili
anche su fusto
gommato.**

*Pad and screen printing also
available on rubberised barrel.*

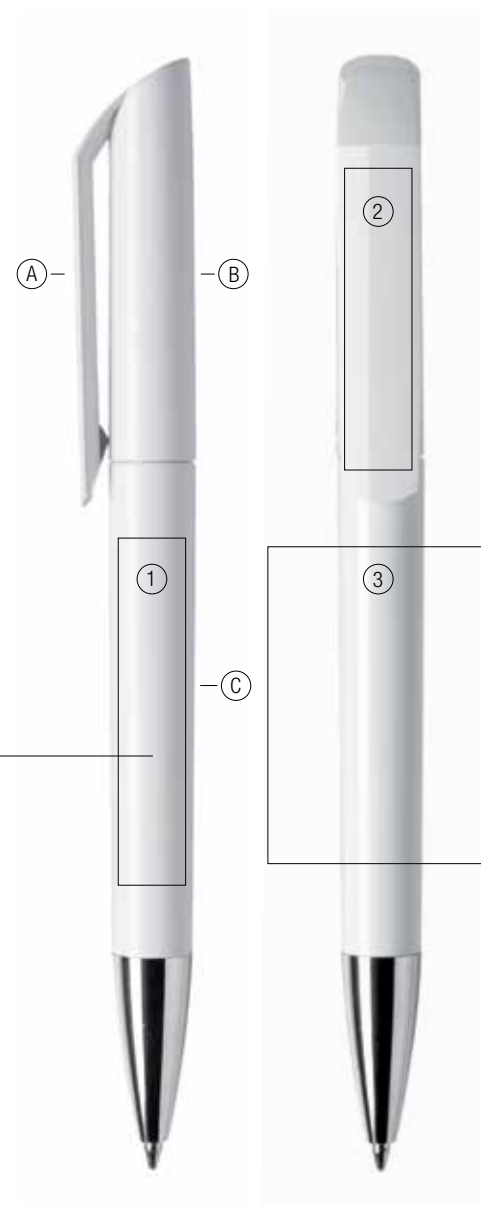

È possibile combinare particolari di colori diversi della stessa versione (o codice), oppure abbinare elementi di versioni differenti.

You can combine differently coloured parts from the same version (or code number), or elements from different versions.

- A** clip
- B** cappuccio
- C** fusto
- A** clip
- B** cap
- C** barrel

1/6

CARATTERISTICHE

- meccanismo a rotazione
- realizzata in plastica ABS, atossica e ad alta resistenza
- la cromatura della punta è ottenuta con trattamento galvanico
- refill Jumbo, inchiostro blu e nero
- il fusto è disponibile con superfici lucide o gommate
- nella versione Texture il cappuccio satinato è percorso interamente da una trama a nido d'ape

FEATURES

- twist-action
- made of non-toxic highly resistant ABS plastic
- galvanic process used to chrome tip
- Jumbo refill, blue and black ink
- the barrel is available in glossy or rubberised finish
- in the Texture version, the entire matt cap features a honeycomb design

2/6

AREA STAMPABILE

- 1 tampografia 46 x 9 mm
- 2 tampografia 40 x 9 mm
- 3 serigrafia 42 x 30 mm

PRINT AREA

- 1 pad printing 46 x 9 mm
- 2 pad printing 40 x 9 mm
- 3 screen printing 42 x 30 mm

3/6

FUSTO

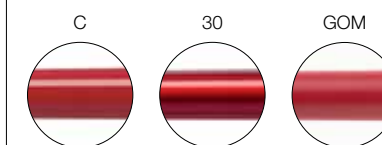

BARREL

4/6

CAPPUCCIO

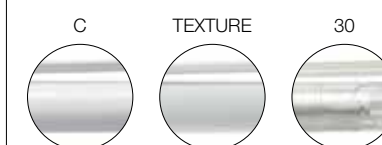

CAP

5/6

PUNTA

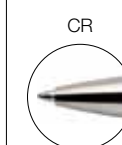

TIP

6/6

COLORAZIONI

- coprenti
 - 01 70 03 18 15 74 60 61 71
- trasparenti
 - 39 52 53 45 59 41 51 31 55
- trattamento galvanico

COLOURS

- solid
 - 25 73 79 09 75 26 27 64 77 12 22 05 04
- transparent
 - 37 38 78 49 47 34 67 44 30 50
- galvanic process

Flow

F1 – BC CR

fusto e clip in colore bianco coprente lucido,
cappuccio in colore coprente con finitura lucida, punta cromata
solid glossy white colour barrel and clip, solid colour cap
with glossy finish, chromed tip

**La clip dal profilo
affilato e aerodinamico
è indipendente dal
cappuccio che la ospita
per permettere nuovi
contrasti cromatici.**

*The slender, aerodynamic clip
is independent of the cap,
thus permitting new colour contrasts.*



18 arancio / tampografia 40 x 9 mm
18 orange / pad printing 40 x 9 mm



77 ciano / tampografia 46 x 9 mm
77 cyan / pad printing 46 x 9 mm

04 nero / tampografia 40 x 9 mm
04 black / pad printing 40 x 9 mm

77 ciano / tampografia 40 x 9 mm
77 cyan / pad printing 40 x 9 mm



Flow

F1 – B 30 CR

fusto e cappuccio in colore bianco coprente lucido,
clip in colore trasparente con finitura lucida, punta cromata
solid white barrel and cap with glossy finish, transparent
colour clip with glossy finish, chromed tip

53 arancio / tampografia 40 x 9 mm
53 orange / pad printing 40 x 9 mm

31 lilla / tampografia 40 x 9 mm
31 lilac / pad printing 40 x 9 mm

50 grigio scuro / tampografia 40 x 9 mm
50 dark grey / pad printing 40 x 9 mm

Costante lavoro di ricerca sui materiali e il design, in linea con le tendenze del momento, per offrire una penna che sappia enfatizzare l'immagine dell'azienda che ospita.

Continuing research into materials and design geared to the latest trends for a pen that is sure to project a high-profile company image.



Flow

F1 – C CR

colori coprenti con finitura lucida, punta cromata
solid colours with glossy finish, chromed tip



Flow

F1 – 30 CR

colori trasparenti con finitura lucida, punta cromata
transparent colours with glossy finish, chromed tip



52



53



45



59



41



51



31



55



37



38



78



49



47



34



67



30



50

39 neutro / tampografia 40 x 9 mm
39 neutral / pad printing 40 x 9 mm

44 blu / tampografia 40 x 9 mm
44 blue / pad printing 40 x 9 mm

Flow TEXTURE

F1 T – GOM C CR

fusto in colore coprente gommato, clip in colore coprente lucido, cappuccio
texturizzato in colore coprente con finitura satinata, punta cromata
solid colour barrel with rubber finish, solid colour clip with glossy finish,
textured solid colour cap with matt finish, chromed tip

18 arancio / tampografia 40 x 9 mm
18 orange / pad printing 40 x 9 mm



01 70 03



15 74 60 61 71 25 73



79 09 75 26 27 64 77 12 22 05

04 nero / tampografia 40 x 9 mm
04 black / pad printing 40 x 9 mm

**Elemento distintivo:
cappuccio arricchito
da una texture.**

Distinctive feature: textured cap.



Flow TEXTURE

F1 T – GOM CB CR

fusto in colore coprente gommato, clip in colore bianco lucido, cappuccio texturizzato in colore coprente con finitura satinata, punta cromata
solid colour barrel with rubber finish, solid glossy white colour clip, textured solid colour cap with matt finish, chromed tip

73 marrone / tampografia 40 x 9 mm
73 brown / pad printing 40 x 9 mm



03 18 15 74 60 61 71 25



79



09 75 27 64 77 12 22

26 acquamarina / tampografia 40 x 9 mm
26 aquamarine / pad printing 40 x 9 mm



Texture costituita da piccole celle esagonali che ricordano un nido d'ape: un design dinamico che dona eleganza visiva e tattile.

Textured with small hexagonal cells that recall a honeycomb: a dynamic design of visual and tactile elegance.

05 grigio / tampografia 40 x 9 mm
05 grey / pad printing 40 x 9 mm



Flow TEXTURE

F1 T – GOM 30 CR

fusto in colore coprente gommato, clip in colore trasparente lucido,
cappuccio texturizzato in colore coprente con finitura satinata, punta cromata
solid colour barrel with rubber finish, transparent glossy colour clip,
textured solid colour cap with matt finish, chromed tip



39 52 53 45



59 rosa / tampografia 40 x 9 mm
59 pink / pad printing 40 x 9 mm



41 31 55 37



38 78 49 47



30 grigio chiaro / tampografia 40 x 9 mm
30 light grey / pad printing 40 x 9 mm



67 44



50

Dot

diversa da tutte, punto
different from the rest, full stop



**È nei dettagli
che rivela
la sua originalità.**

*A pen that reveals
its originality in its details.*

Dot
informazioni
tecniche
*technical
information*

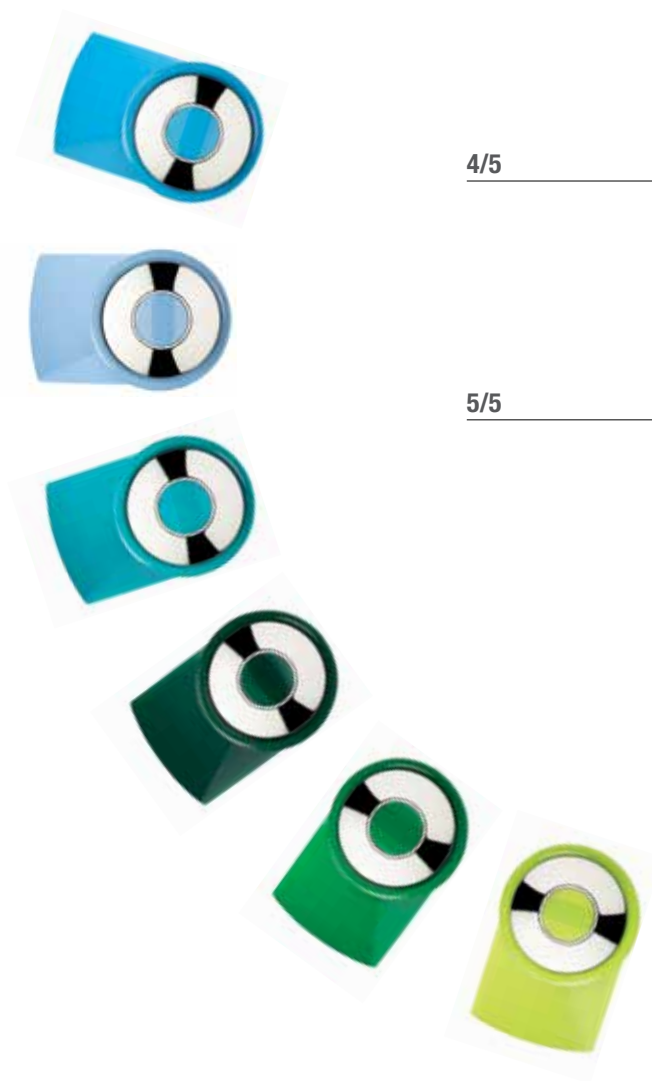
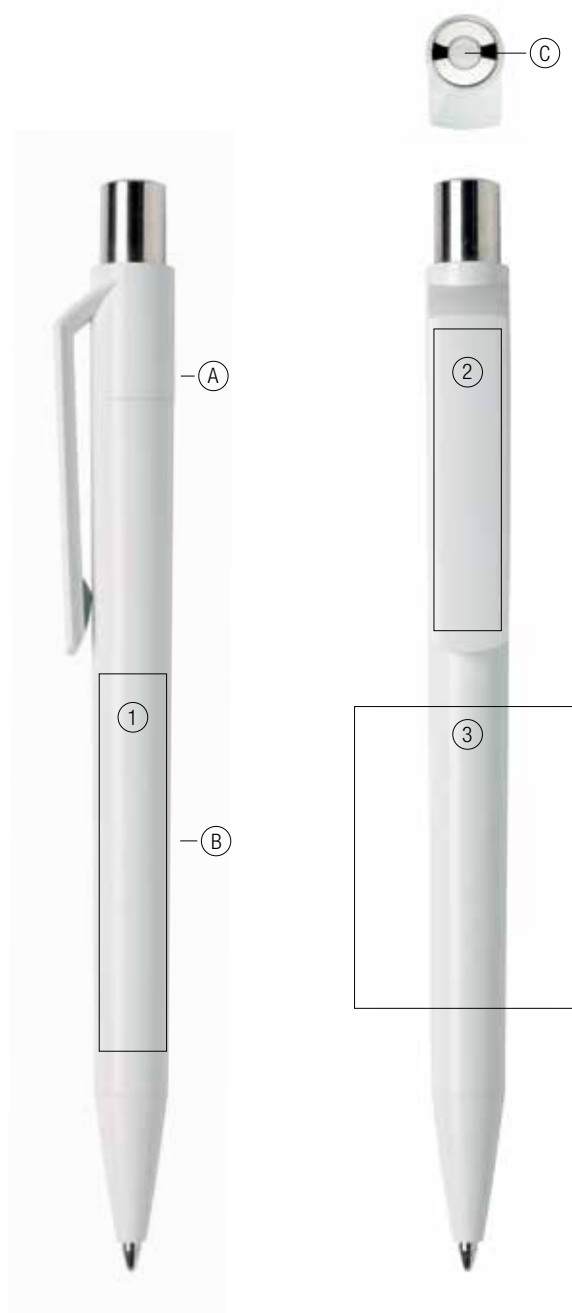

È possibile combinare particolari di colori diversi della stessa versione (o codice), oppure abbinare elementi di versioni differenti.

You can combine differently coloured parts from the same version (or code number), or elements from different versions.

- A** clip
- B** fusto
- C** piccola sfera
- A** clip
- B** barrel
- C** little sphere

1/5

CARATTERISTICHE

- meccanismo a scatto, con molla di ritorno
- realizzata in plastica ABS atossica e ad alta resistenza
- la cromatura e la doratura del tappino sono ottenute con trattamento galvanico
- refill Jumbo, inchiostro blu e nero
- il fusto è disponibile con superfici lucide o gommate
- le versioni con fusto gommato sono stampabili solo su clip

FEATURES

- retractable with return spring
- made of non-toxic, highly resistant ABS plastic
- galvanic process used to chrome and gold ABS push-button
- Jumbo refill, blue and black ink
- the barrel is available in glossy or rubberised finish
- rubberised barrel versions are only printable on the clip

2/5

AREA STAMPABILE

- 1 tampografia 50 x 9 mm
- 2 tampografia 40 x 9 mm
- 3 serigrafia 40 x 30 mm

PRINT AREA

- 1 pad printing 50 x 9 mm
- 2 pad printing 40 x 9 mm
- 3 screen printing 40 x 30 mm

3/5

FUSTO

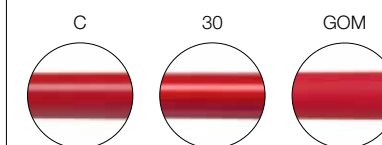

BARREL

4/5

TAPPINO

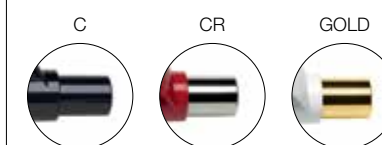

PUSH-BUTTON

5/5

COLORAZIONI

- coprenti
 - 01 70 03 18 15 74 60 61 71
- trasparenti
 - 39 52 53 45 59 41 31 55 37
- fluo coprenti
 - 02 17 14 56 08
- fluo trasparenti
 - 20 33 24 46 48
- trattamento galvanico
 - ●

COLOURS

- solid
 - 25 72 73 79 09 75 26 27 64 77 12 22 05 04
- transparent
 - 38 78 49 47 34 67 44 30 50
- solid fluo
- transparent fluo
- galvanic process

Dot

D1 – B CR

fusto e clip in colore bianco coprente con finitura lucida,
piccola sfera in colore coprente lucido, tappino cromato
solid white colour barrel and clip with glossy finish,
solid glossy colour little sphere, chromed push-button



03 giallo / tampografia 40 x 9 mm
03 yellow / pad printing 40 x 9 mm



**La superficie bianca
è la base creativa
per eccellenza: libertà
di espressione e massima
resa cromatica.**

*A white surface is the creative foundation
par excellence: freedom of expression
and top colour rendering.*



18



15



74



60



61



71



25



73



79



09

Total white: semplice ed elegante
grazie al raffinato dettaglio di colore.

*Total white: simple and elegant thanks
to its refined color detail.*



75



27



64



77



12



22



05



04

Dot

D1 – BC CR

fusto bianco coprente lucido, clip e piccola sfera
in colore coprente con finitura lucida, tappino cromato
solid glossy white colour barrel, solid colour clip
and little sphere with glossy finish, chromed push-button



61 magenta / tampografia 40 x 9 mm
61 magenta / pad printing 40 x 9 mm



71 25 72 73



75 verde scuro / tampografia 40 x 9 mm
75 dark green / pad printing 40 x 9 mm



79 09



27 64 77 12 22



05 grigio / tampografia 40 x 9 mm
05 grey / pad printing 40 x 9 mm



04

**Estetica della clip
molto ricercata,
per far risaltare
la forza e il carattere
di ogni brand.**

The clip is of highly refined appearance to highlight the strength and personality of each brand.

Dot

D1 – B 30 CR

fusto bianco coprente lucido, clip in colore
trasparente con finitura lucida, piccola sfera
in colore coprente lucido, tappino cromato
solid glossy white colour barrel, transparent colour
clip with glossy finish, solid glossy colour little
sphere, chromed push-button

**Il meccanismo è a scatto
con molla di ritorno
in tutte le combinazioni.**

Retractable with return spring in all versions.



39

52

53

45

41



55 viola scuro / tampografia 40 x 9 mm
55 dark violet / pad printing 40 x 9 mm



37



38

78



49 verde / tampografia 40 x 9 mm
49 green / pad printing 40 x 9 mm



47

67

44

50

Dot D1 – CB CR

fusto e piccola sfera in colore coprente lucido,
clip in colore bianco lucido, tappino cromato
solid colour barrel and little sphere with glossy finish,
solid glossy white colour clip, chromed push-button



15 rosso / tampografia 40 x 9 mm
15 red / pad printing 40 x 9 mm



04 nero / tampografia 40 x 9 mm
04 black / pad printing 40 x 9 mm



Dot

D1 – C CR

colori coprenti con finitura lucida, tappino cromato
solid colours with glossy finish, chromed push-button



70

03

15

60

61

71

25

73

79

09

75

27

77

12

22

05

18 arancio / tampografia 40 x 9 mm
18 orange / pad printing 40 x 9 mm

74 bordeaux / tampografia 40 x 9 mm
74 burgundy / pad printing 40 x 9 mm

64 azzurro pastello / tampografia 40 x 9 mm
64 pastel blue / pad printing 40 x 9 mm

04 nero / tampografia 40 x 9 mm
04 black / pad printing 40 x 9 mm

Dot

D1 – 30 CR

colori trasparenti con finitura lucida, piccola sfera
in colore coprente lucido, tappino cromato
transparent colours with glossy finish, solid glossy
colour little sphere, chromed push-button

**Le componenti di Dot
si prestano ad originali
accostamenti cromatici per
soddisfare ogni esigenza
di personalizzazione.**

*Dot components permit original colour combinations
to cater to all personalisation requirements.*



39



53

45

41

55

37

38

52 giallo / tampografia 40 x 9 mm
52 yellow / pad printing 40 x 9 mm



78 lime / tampografia 40 x 9 mm
78 lime / pad printing 40 x 9 mm



49

47

67

44

50

Dot

D1 – GOM K

fusto in colore nero coprente gommato,
clip e tappino in colore nero coprente lucido,
piccola sfera in colore coprente lucido
solid black colour barrel with rubber finish,
solid black colour clip and push-button
with glossy finish, solid glossy colour little sphere

NEW



**L'eleganza del nero
si combina con
la finitura soft touch
per un risultato
di grande impatto.**

*The elegance of black combines with
a soft touch finish for a high-impact result.*



01



70 crema / tampografia 40 x 9 mm
70 cream / pad printing 40 x 9 mm



03



18



15



74



60



61



71



25



72



73

Total black
con nota di colore.

Total black with a note of colour.



79



09



75



26



27



77



12



22



05



04

Dot

D1 – GOM CB CR

fusto in colore coprente gommato, clip in colore bianco lucido,
piccola sfera in colore coprente lucido, tappino cromato
solid colour barrel with rubber finish, solid glossy white colour clip,
solid glossy colour little sphere, chromed push-button



25 viola scuro / tampografia 40 x 9 mm
25 dark violet / pad printing 40 x 9 mm

64 azzurro pastello / tampografia 40 x 9 mm
64 pastel blue / pad printing 40 x 9 mm

18 arancio / tampografia 40 x 9 mm
18 orange / pad printing 40 x 9 mm

05 grigio / tampografia 40 x 9 mm
05 grey / pad printing 40 x 9 mm

Dot D1 – GOM C CR

fusto in colore coprente gommato, clip e piccola sfera
in colore coprente con finitura lucida, tappino cromato
solid colour barrel with rubber finish, solid colour clip
and little sphere with glossy finish, chromed push-button



71 viola chiaro / tampografia 40 x 9 mm
71 light violet / pad printing 40 x 9 mm



03 giallo / tampografia 40 x 9 mm
03 yellow / pad printing 40 x 9 mm



22 blu / tampografia 40 x 9 mm
22 blue / pad printing 40 x 9 mm



Dot

D1 – GOM 30 CR

fusto in colore coprente gommato, clip in colore trasparente con finitura lucida, piccola sfera in colore coprente lucido, tappino cromato
solid colour barrel with rubber finish, transparent colour clip with glossy finish, solid glossy colour little sphere, chromed push-button



38 marrone / tampografia 40 x 9 mm
38 brown / pad printing 40 x 9 mm



50 grigio scuro / tampografia 40 x 9 mm
50 dark grey / pad printing 40 x 9 mm

Dot
D1 – C GOLD

colori coprenti con finitura
lucida, tappino dorato
solid colours with glossy finish,
gilded push-button



04

01 bianco / tampografia 40 x 9 mm
01 white / pad printing 40 x 9 mm

Dot
D1 – GOM CB F CR

fusto in colore fluo coprente gommatto, clip in colore bianco coprente lucido,
piccola sfera in colore fluo coprente lucido, tappino cromato
solid fluo colour barrel with rubber finish, solid glossy white colour clip,
solid glossy fluo colour little sphere, chromed push-button

**fluo
colours**



17

14

56

08

02 giallo / tampografia 40 x 9 mm
02 yellow / pad printing 40 x 9 mm



NEW

MY BOX

Astuccio universale
richiudibile per
penna singola
in cartoncino nero
Fedrigoni.
Info pag. 221

Universal reclosable
single pen
box in Fedrigoni
black card.
Info at p. 221

Dot
D1 – GOM KF CR

fusto in colore nero coprente gommato, clip e piccola sfera in colore fluo coprente lucido, tappino cromato
solid black colour barrel with rubber finish, solid fluo colour clip and little sphere with glossy finish, chromed push-button



17 arancio / tampografia 40 x 9 mm
17 orange / pad printing 40 x 9 mm



02



14 rosso corallo / tampografia 40 x 9 mm
14 coral red / pad printing 40 x 9 mm



56



08

Dot
D1 – GOM 30 F CR

fusto in colore fluo coprente gommato, clip in colore fluo trasparente lucido, piccola sfera in colore fluo coprente lucido, tappino cromato
solid fluo colour barrel with rubber finish, transparent glossy fluo colour clip, solid glossy fluo colour little sphere, chromed push-button



20



33



24



46

48 verde / tampografia 40 x 9 mm
48 green / pad printing 40 x 9 mm



Zink

solide geometrie
solid geometries

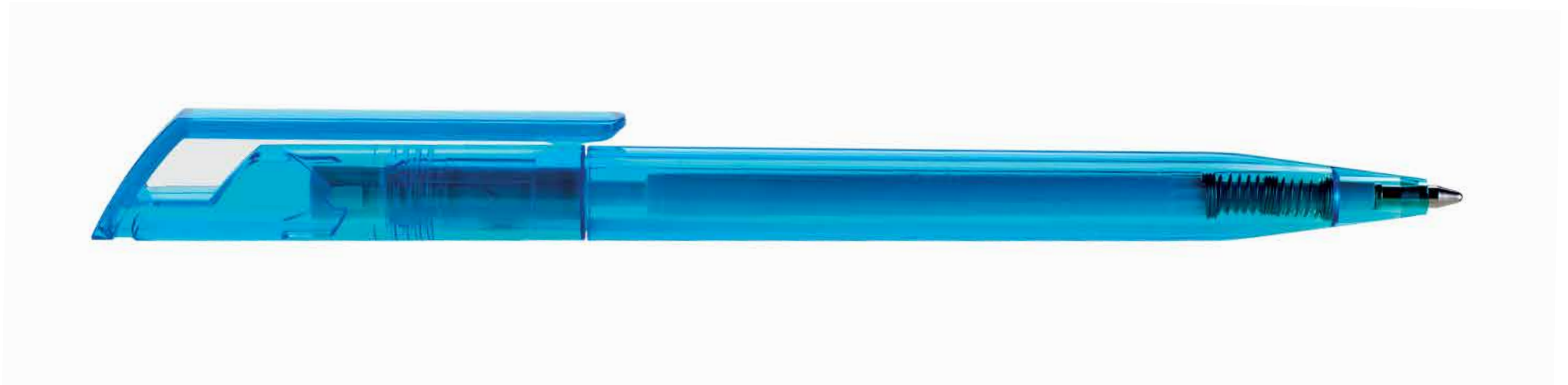

**Una penna
dal profilo tagliente
e dal carattere deciso.**

*A pen with a clean-cut profile
and strong personality.*

Zink

informazioni tecniche

technical information

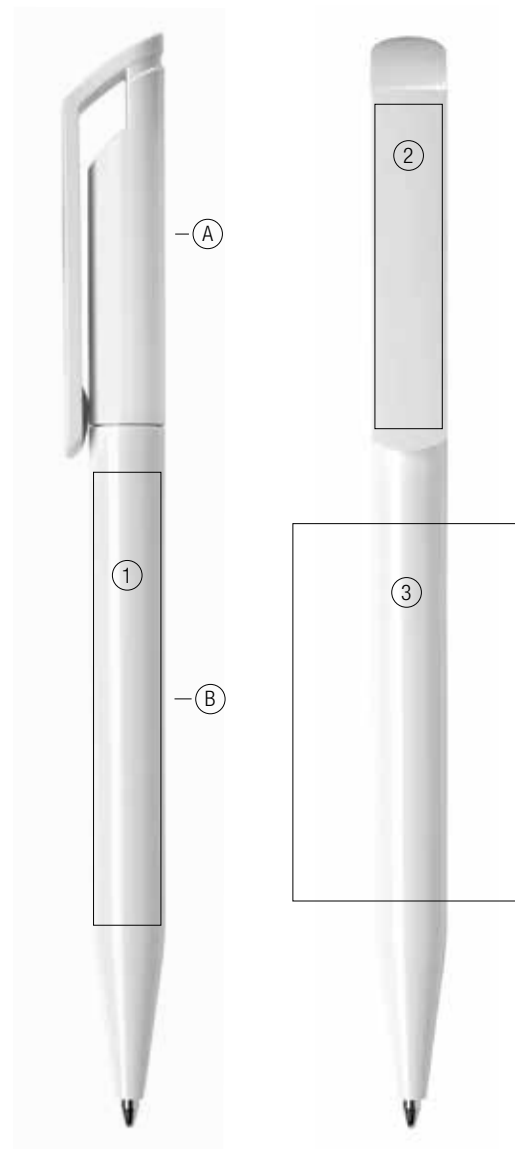

NEW

MY CASE

Astuccio universale per penna singola in cartoncino nero Fedrigoni. Info pag. 220

Universal single pen box in Fedrigoni black card. Info at p. 220

1/5

CARATTERISTICHE

- meccanismo a rotazione
- realizzata in plastica ABS atossica e ad alta resistenza
- refill Jumbo, inchiostro blu e nero
- disponibile con superfici lucide

FEATURES

- twist-action
- made of non-toxic, highly resistant ABS plastic
- Jumbo refill, blue and black ink
- available in glossy finish

2/5

AREA STAMPABILE

- 1 tampografia 60 x 9 mm
- 2 tampografia 43 x 9 mm
- 3 serigrafia 50 x 30 mm

PRINT AREA

- 1 pad printing 60 x 9 mm
- 2 pad printing 43 x 9 mm
- 3 screen printing 50 x 30 mm

3/5

FUSTO

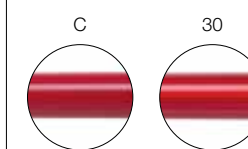

BARREL

4/5

CAPPUCCIO

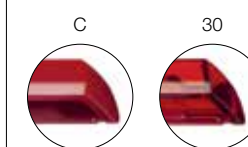

CAP

5/5

COLORAZIONI

- coprenti



- trasparenti



- fluo coprenti



COLOURS

- solid

- transparent

- solid fluo

È possibile combinare particolari di colori diversi della stessa versione (o codice), oppure abbinare elementi di versioni differenti.

You can combine differently coloured parts from the same version (or code number), or elements from different versions.

A cappuccio

A cap

B fusto

B barrel

Zink Z1 - C

colori coprenti con finitura lucida
solid colours with glossy finish

**Architettura corposa
e robusta per un profilo
dal rigore geometrico.**

*Solid, sturdy architecture
for a profile of geometric precision.*



Zink

Z1 – B 30

fusto bianco coprente lucido, cappuccio
in colore trasparente con finitura lucida
solid glossy white barrel, transparent
colour cap with glossy finish

41 magenta / tampografia 43 x 9 mm
41 magenta / pad printing 43 x 9 mm



39 52 53 45



51 55 37 38

**La clip colpisce per la sua
lunghezza, una garanzia
di forte impatto visivo.**

*The clip's striking length guarantees
a strong visual impact.*



49 47 67 44 50

78 lime / tampografia 43 x 9 mm
78 lime / pad printing 43 x 9 mm

Zink Z1 – 30

colori trasparenti con finitura lucida
transparent colours with glossy finish

37 ambra / tampografia 43 x 9 mm
37 amber / pad printing 43 x 9 mm



67 ciano / tampografia 43 x 9 mm
67 cyan / pad printing 43 x 9 mm

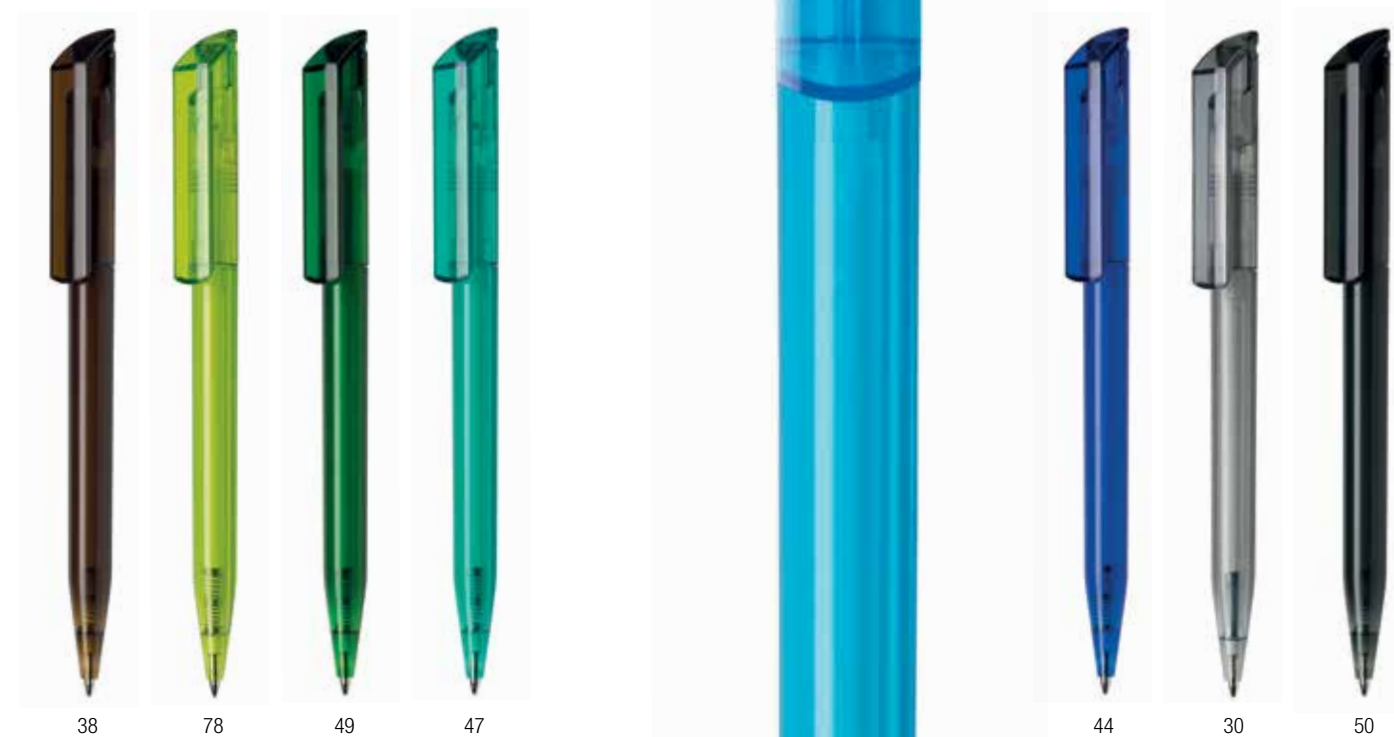

**Il fusto slanciato bilancia
la solida struttura.**

*Its sturdy structure is offset by
the slim, streamlined barrel.*

Zink Z1 – CF

colori fluo coprenti con finitura lucida
solid fluo colours with glossy finish

**fluo
colours**



02



17 arancio / tampografia 43 x 9 mm
17 orange / pad printing 43 x 9 mm



14



56

**Colori fluo,
tonalità intense
e vibranti.**

*Fluo colours, intense
and vibrant shades.*



08 verde / tampografia 43 x 9 mm
08 green / pad printing 43 x 9 mm

View

carattere incisivo
decisive personality



**Sprigiona grinta
da ogni punto
di vista e affascina
per l'eleganza.**

*Exudes boldness from every angle
and captivates with its elegance.*

View
informazioni
tecniche
*technical
information*

**Soluzioni di
stampa sulla
clip in metallo.**

*Print solutions
for the metal clip.*

- ① tampografia 40 x 6 mm
pad printing 40 x 6 mm
- ② incisione laser 30 x 7 mm
laser engraving 30 x 7 mm

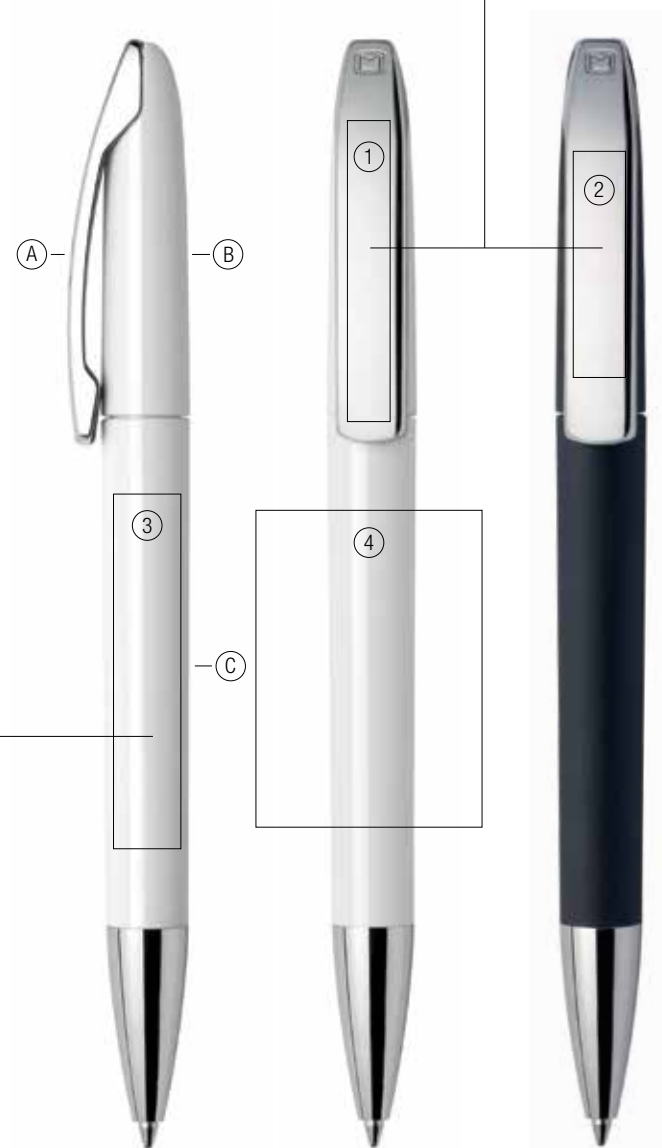

**Tampografia
e serigrafia
disponibili
anche su fusto
gommato.**

*Pad and screen printing also
available on rubberised barrel.*

È possibile combinare particolari di colori diversi della stessa versione (o codice), oppure abbinare elementi di versioni differenti.

You can combine differently coloured parts from the same version (or code number), or elements from different versions.

- Ⓐ clip
- Ⓑ cappuccio
- Ⓒ fusto
- Ⓐ clip
- Ⓑ cap
- Ⓒ barrel

1/5

CARATTERISTICHE

- meccanismo a rotazione
- realizzata in plastica ABS atossica e ad alta resistenza
- clip in metallo cromato disponibile per incisione laser e tampografia.
- la cromatura della punta è ottenuta con trattamento galvanico
- refill Jumbo, inchiostro blu e nero
- disponibile con superfici lucide, gommate o verniciate in colore alluminio

FEATURES

- twist-action
- made of non-toxic, highly resistant ABS plastic
- metal chrome finish clip available for laser engraving and pad printing
- galvanic process used to chrome tip
- Jumbo refill, blue and black ink
- available in glossy, matt, rubberised or aluminium painted finish

2/5

AREA STAMPABILE

- ③ tampografia 47 x 9 mm
- ④ serigrafia 42 x 30 mm

PRINT AREA

- ③ pad printing 47 x 9 mm
- ④ screen printing 42 x 30 mm

3/5

FUSTO

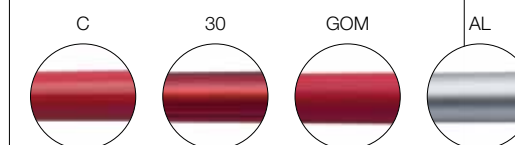

BARREL

4/5

PUNTA

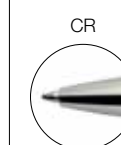

TIP

5/5

COLORAZIONI

- coprenti



- trasparenti



- vernici metallizzate



- trattamento galvanico



COLOURS

- solid



- transparent



- metallic paintings

- galvanic process

View

V1 – C CR / V1 – C CRT *

colori coprenti con finitura lucida,
clip in metallo cromato, punta cromata
solid colours with glossy finish,
metal chrome finish clip, chromed tip

**La linea affilata del cappuccio
dà armonia e bilancia
l'imponenza della clip.**

*The sleek design of the cap adds elegance
and balances the large clip.*



60 rosa / incisione laser 30 x 7 mm
60 pink / laser engraving 30 x 7 mm



(*)
V1 – C CR clip per incisione laser /
clip for laser engraving
V1 – C CRT clip per tampografia /
clip for pad printing

79 lime / serigrafia 42 x 30 mm
79 lime / screen printing 42 x 30 mm



22 blu / tampografia su clip 40 x 6 mm
22 blue / pad printing on the clip 40 x 6 mm



View

V1 – 30 CR / V1 – 30 CR T *

colori trasparenti con finitura lucida,
clip in metallo cromato, punta cromata
transparent colours with glossy finish,
metal chrome finish clip, chromed tip



39 neutro / serigrafia 42 x 30 mm
39 neutral / screen printing 42 x 30 mm

(*)
V1 – 30 CR
clip per incisione laser /
clip for laser engraving
V1 – 30 CR T
clip per tampografia /
clip for pad printing

View

V1 – AL CR / V1 – AL CR T *

fusto e cappuccio verniciati in colore alluminio,
clip in metallo cromato, punta cromata
aluminium painted finish barrel and cap,
metal chromed clip, chromed tip



**Valorizza il prestigio
di un marchio con
raffinata eleganza.**

*Refined elegance to enhance
the prestige of a brand.*

alluminio / incisione laser 30 x 7 mm
aluminium / laser engraving 30 x 7 mm

(*)
V1 – AL CR
clip per incisione laser /
clip for laser engraving
V1 – AL CR T
clip per tampografia /
clip for pad printing

View

V1 – GOM C CR / V1 – GOM C CR T *

fusto e cappuccio in colore coprente gommato,
clip in metallo cromato, punta cromata
solid colour barrel and cap with rubber finish,
metal chrome clip, chromed tip



61 magenta / serigrafia 42 x 30 mm
61 magenta / screen printing 42 x 30 mm



tampografia
pad printing

**Via libera ai colori,
anche su metallo!**

*Free rein to colours
on metals too!*

64 azzurro pastello / incisione laser 30 x 7 mm
64 pastel blue / laser engraving 30 x 7 mm



04 nero / tampografia su clip 40 x 6 mm
04 black / pad printing on the clip 40 x 6 mm



(*)
V1 – GOM C CR
clip per incisione laser /
clip for laser engraving
V1 – GOM C CR T
clip per tampografia /
clip for pad printing

18 arancio / tampografia su clip 40 x 6 mm
18 orange / pad printing on the clip 40 x 6 mm

Tag

eleganza imponente
imposing elegance



**Design semplice
e raffinato, omaggio
all'eleganza perfetta.**

*Clean-cut, refined design,
a tribute to perfect elegance.*

Tag
informazioni
tecniche
*technical
information*

**Tampografia
e serigrafia
disponibili
anche su fusto
gommato.**

*Pad and screen printing also
available on rubberised barrel.*

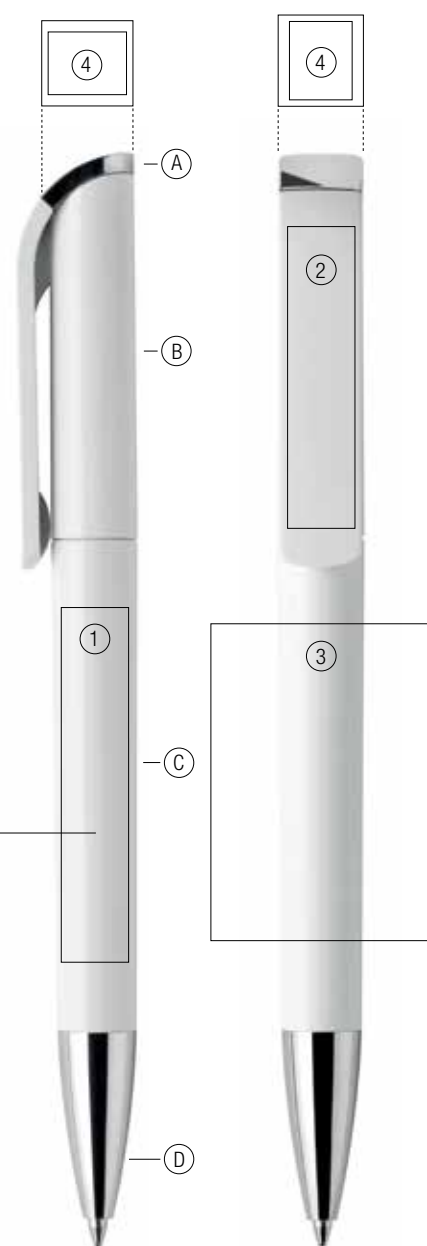

- | | |
|------------|----------|
| Ⓐ tassello | Ⓐ plug |
| Ⓑ clip | Ⓑ clip |
| Ⓒ fusto | Ⓒ barrel |
| Ⓓ punta | Ⓓ tip |

È possibile combinare particolari di colori diversi della stessa versione (o codice), oppure abbinare elementi di versioni differenti.

You can combine differently coloured parts from the same version (or code number), or elements from different versions.

1/5

CARATTERISTICHE

- meccanismo a rotazione
- realizzata in plastica ABS atossica e ad alta resistenza
- la cromatura della punta e del tassello superiore è ottenuta con trattamento galvanico
- refill Jumbo, inchiostro blu e nero
- disponibile con superfici lucide, satinare, gommate o verniciate con colori metallizzati o alluminio

FEATURES

- twist-action
- made of non-toxic, highly resistant ABS plastic
- galvanic process used to chrome tip and upper plug
- Jumbo refill, blue and black ink
- available in glossy, matt, rubberised and metallic or aluminium painted finish

2/5

AREA STAMPABILE

- ① tampografia 47 x 9 mm
- ② tampografia 40 x 9 mm
- ③ serigrafia 42 x 30 mm
- ④ tampografia 8 x 10 mm

PRINT AREA

- ① pad printing 47 x 9 mm
- ② pad printing 40 x 9 mm
- ③ screen printing 42 x 30 mm
- ④ pad printing 8 x 10 mm

3/5

FUSTO

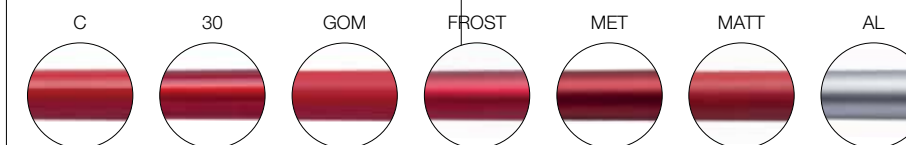

BARREL

4/5

PUNTA E TASSELLO

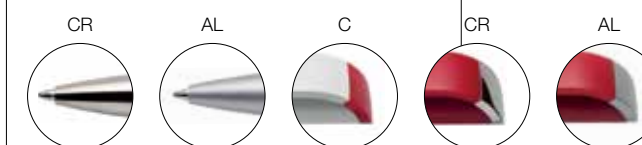

TIP AND PLUG

5/5

COLORAZIONI

- coprenti
 - 01 70 03 18 15 74 60 61 71 25 72 73 79 09 75 27 64 12 22 04
- trasparenti
 - 39 52 53 45 51 55 49 47 44 40
- vernici metallizzate
 - 92 83 85 94 95 96
- trattamento galvanico

COLOURS

- solid
- transparent
- metallic paintings
- galvanic process

Tag

TA1 – MATT AL B

colori coprenti con finitura satinata, tassello superiore in colore coprente con finitura lucida, punta verniciata in colore alluminio
solid colours with matt finish, solid colour upper plug with glossy finish, aluminium painted finish tip



01 bianco / tampografia 40 x 9 mm
01 white / pad printing 40 x 9 mm

serigrafia 42 x 30 mm
screen printing 42 x 30 mm



61 magenta / tampografia 40 x 9 mm
61 magenta / pad printing 40 x 9 mm



64 azzurro pastello / tampografia 40 x 9 mm
64 pastel blue / pad printing 40 x 9 mm



Tag TA1 – B CR

colori coprenti con finitura lucida, punta cromata
solid colours with glossy finish, chromed tip



15 rosso / tampografia 40 x 9 mm
15 red / pad printing 40 x 9 mm

04 nero / tampografia 40 x 9 mm
04 black / pad printing 40 x 9 mm

Tag TA1 – CB CR

colori coprenti con finitura lucida, punta cromata
solid colours with glossy finish, chromed tip



18 arancio / tampografia 40 x 9 mm
18 orange / pad printing 40 x 9 mm

61 magenta / tampografia 40 x 9 mm
61 magenta / pad printing 40 x 9 mm

Tag

TA1 – MATT AL

colori coprenti con finitura satinata, tassello superiore e punta verniciati in colore alluminio
solid colours with matt finish, aluminium painted finish upper plug and tip



01 bianco / tampografia 40 x 9 mm
01 white / pad printing 40 x 9 mm



03



15

61

25

79

09

22

04

18 arancio / tampografia 40 x 9 mm
18 orange / pad printing 40 x 9 mm

Tag

TA1 – FROST AL

colori trasparenti con finitura satinata, tassello superiore e punta verniciati in colore alluminio
transparent colours with matt finish, aluminium painted finish upper plug and tip



52 giallo / tampografia 40 x 9 mm
52 yellow / pad printing 40 x 9 mm



39



53



51

55

49

47

44

40

45 rosso / tampografia 40 x 9 mm
45 red / pad printing 40 x 9 mm

Lo stile rigoroso è ingentilito dalla dolce curvatura della clip e del suo tassello di chiusura.

Its rigorous styling is softened by the smooth curve of the clip and closing plug.

Tag

TA1 – C CR

colori coprenti con finitura lucida,
tassello superiore e punta cromati
solid colours with glossy finish,
chromed upper plug and tip

**Eleganza e linearità
per esprimere tutta
la forza di un brand.**

*Elegance and linearity to express
all the strength of a brand.*

01 bianco / tampografia 40 x 9 mm
01 white / pad printing 40 x 9 mm



70 03 18 15 74 60 61 71 25 72

64 azzurro pastello / tampografia 40 x 9 mm
64 pastel blue / pad printing 40 x 9 mm



79 09 75 27

73 marrone / tampografia 40 x 9 mm
73 brown / pad printing 40 x 9 mm



12 22 04

Tag TA1 – 30 CR

colori trasparenti con finitura lucida,
tassello superiore e punta cromati
transparent colours with glossy finish,
chromed upper plug and tip

44 blu / tampografia 40 x 9 mm
44 blue / pad printing 40 x 9 mm

tampografia 47 x 9 mm
pad printing 47 x 9 mm



Tag TA1 – GOM C CR

fusto in colore coprente gommato, clip in colore coprente
con finitura lucida, tassello superiore e punta cromati
solid colour barrel with rubber finish, solid colour clip
with glossy finish, chromed upper plug and tip

**Fusto gommato: piace
perché è bello da
vedere e da toccare.**

*Rubber finish barrel: popular because
it is good to look at and pleasant to touch.*

04 nero / tampografia 40 x 9 mm
04 black / pad printing 40 x 9 mm



72 cuoio / tampografia 40 x 9 mm
72 leather / pad printing 40 x 9 mm



Tag

TA1 – MET AL

fusto e clip verniciati in colori metallizzati, tassello superiore e punta verniciati in colore alluminio
metallic colours painted finish barrel and clip, aluminium painted finish upper plug and tip



92

83



85 rosso / tampografia 40 x 9 mm
85 red / pad printing 40 x 9 mm



94

95

96



NEW

MY BOX

Astuccio universale richiudibile per penna singola in cartoncino nero Fedrigoni.
Info pag. 221

Universal reclosable single pen box in Fedrigoni black card.
Info at p. 221

Tag

TA1 – AL CR

fusto e clip verniciati in colore alluminio, tassello superiore e punta cromati
aluminium painted finish barrel and clip, chromed upper plug and tip

alluminio / tampografia 40 x 9 mm
aluminum / pad printing 40 x 9 mm



Icon

design senza tempo
timeless design



**L'incontro tra passato,
presente e futuro.**

*A perfect synthesis of past,
present and future.*

Icon

informazioni tecniche

technical information

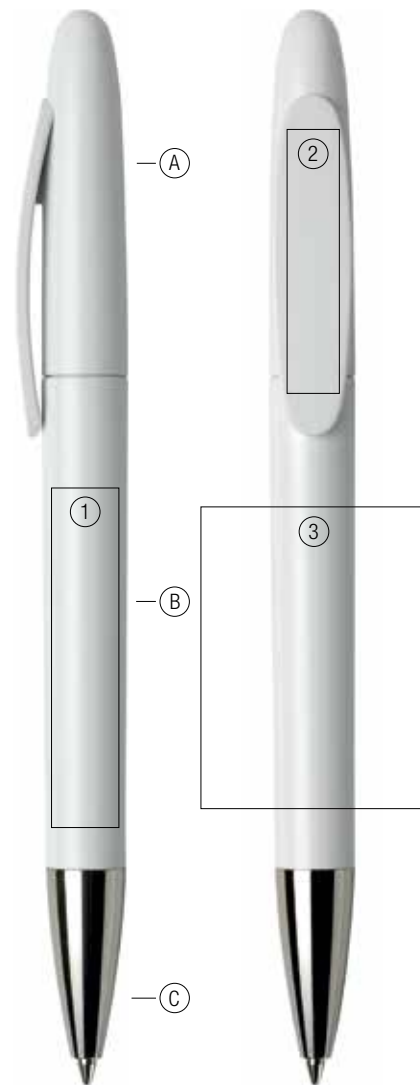

È possibile combinare particolari di colori diversi della stessa versione (o codice), oppure abbinare elementi di versioni differenti.

You can combine differently coloured parts from the same version (or code number), or elements from different versions.

- A cappuccio A cap
- B fusto B barrel
- C punta C tip

1/4

CARATTERISTICHE

- meccanismo a rotazione
- realizzata in plastica ABS, atossica e ad alta resistenza
- la cromatura e la doratura della punta in ABS sono ottenute con trattamento galvanico
- refill Jumbo, inchiostro blu e nero
- disponibile con superfici lucide, satinare o verniciate in colori metallizzati o alluminio

FEATURES

- twist-action
- made of non-toxic, highly resistant ABS plastic
- galvanic process used to chrome and gild ABS tip
- Jumbo refill, blue and black ink
- available in glossy, matt and metallic or aluminium painted finish

2/4

AREA STAMPABILE

- ① tampografia 45 x 9 mm
- ② tampografia 35 x 7 mm
- ③ serigrafia 40 x 30 mm

PRINT AREA

- ① pad printing 45 x 9 mm
- ② pad printing 35 x 7 mm
- ③ screen printing 40 x 30 mm

3/5

FUSTO

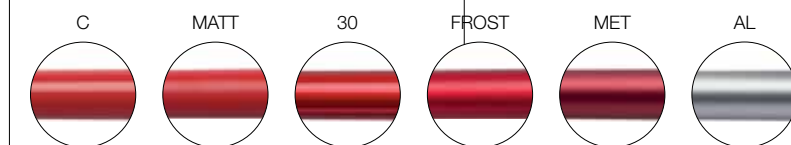

BARREL

4/5

PUNTA



TIP

5/5

COLORAZIONI

- coprenti
- ① 01 70 03 18 15 74 60 61 71
- trasparenti
- ① 39 52 53 45 51 55 49 47 44 40
- vernici metallizzate
- 92 83 85 94 95 96
- trattamento galvanico

COLOURS

- solid
- 25 72 73 79 09 75 27 64 12 22 04
- transparent
- 40
- metallic paintings
- galvanic process

Icon

IC400 – C

colori coprenti con finitura lucida
solid colours with glossy finish

**Design dal profilo
essenziale e armonico per
uno stile mai scontato
e sempre attuale.**

*Essential, harmonious design for a style that
is never banal and always up-to-date.*

18 arancio / tampografia 35 x 7 mm
18 orange / pad printing 35 x 7 mm



25 viola scuro / tampografia 35 x 7 mm
25 dark violet / pad printing 35 x 7 mm

Icon

IC400 – MATT

colori coprenti con finitura satinata
solid colours with matt finish

79 lime / tampografia 35 x 7 mm
79 lime / pad printing 35 x 7 mm



Icon

IC400 – 30

colori trasparenti con finitura lucida
transparent colours with glossy finish

49 verde / tampografia 35 x 7 mm
49 green / pad printing 35 x 7 mm



39 52 53 45 51 55



47 44 40

Icon

IC400 – FROST

colori trasparenti con finitura satinata
transparent colours with matt finish

44 blu / tampografia 35 x 7 mm
44 blue / pad printing 35 x 7 mm



39 52 53 45



55 49 47



40

51 viola / serigrafia 40 x 30 mm
51 violet / screen printing 40 x 30 mm

Icon

IC400 – MATT AL

colori coprenti con finitura satinata,
punta verniciata in colore alluminio
solid colours with matt finish,
aluminium painted finish tip

71 viola chiaro / tampografia 35 x 7 mm
71 light violet / pad printing 35 x 7 mm

18 arancio / tampografia 35 x 7 mm
18 orange / pad printing 35 x 7 mm



Il fusto e la clip sono progettati per offrire ampi spazi di personalizzazione e rispondere alle esigenze di ogni cliente.

The barrel and clip have been designed to provide ample space for personalisation to meet each customer's requirements.

04 nero / serigrafia 40 x 30 mm
04 black / screen printing 40 x 30 mm



27 ottanio / tampografia 35 x 7 mm
27 octan green / pad printing 35 x 7 mm



Icon

IC400 – C CR

colori coprenti con finitura lucida, punta cromata
solid colours with glossy finish, chromed tip



61 magenta / tampografia 35 x 7 mm
61 magenta / pad printing 35 x 7 mm



70 03 18 15 74 60

01 bianco / tampografia 45 x 9 mm
01 white / pad printing 45 x 9 mm



71 25



72



73 marrone / tampografia 35 x 7 mm
73 brown / pad printing 35 x 7 mm



79 09



75 verde scuro / tampografia 35 x 7 mm
75 dark green / pad printing 35 x 7 mm



27 64 12 22 04

Icon IC400 – FROST AL

colori trasparenti con finitura satinata,
punta verniciata in colore alluminio
transparent colours, matt finish,
aluminium painted finish tip



40 grigio / tampografia 35 x 7 mm
40 grey / pad printing 35 x 7 mm

53 arancio / tampografia 35 x 7 mm
53 orange / pad printing 35 x 7 mm

serigrafia 40 x 30 mm
screen printing 40 x 30 mm

39

52

45

51

55

49

47

44

Icon IC400 – 30 CR

colori trasparenti con finitura
lucida, punta cromata
transparent colours with
glossy finish, chromed tip



45 rosso / tampografia 35 x 7 mm
45 red / pad printing 35 x 7 mm

47 acquamarina / tampografia 35 x 7 mm
47 aquamarine / pad printing 35 x 7 mm

39

52

53

51

55

49

44

40

Icon

IC400 – C GOLD

colori coprenti con finitura lucida, punta dorata
solid colours with glossy finish, gilded tip



NEW

MY CASE

Astuccio universale
per penna singola
in cartoncino nero
Fedrigoni.
Info pag. 220

Universal single
pen box in Fedrigoni
black card.
Info at p. 220

04 nero / serigrafia 40 x 30 mm
04 black / screen printing 40 x 30 mm



01

74

75

22



Icon

IC400 – MET AL

fusto e cappuccio verniciati in colori metallizzati,
punta verniciata in colore alluminio
metallic colours painted finish barrel and cap,
aluminium painted finish tip

Esclusivi colori metallizzati ad alta resistenza.

Exclusive **high strength** metallic colours.

alluminio / tampografia 35 x 7 mm
aluminium / pad printing 35 x 7 mm



92

85

94

95

96

83 rame / tampografia 35 x 7 mm
83 copper / pad printing 35 x 7 mm

IC400 – AL CR

fusto e cappuccio verniciati
in colore alluminio,
punta cromata
aluminium painted finish
barrel and cap, chromed tip



Tag green

obiettivo: sicurezza totale
objective: total safety



**Il design sposa
la sicurezza e rispetta
l'ambiente.**

*Design that combines safety
and environment friendliness.*

“Realizzata con plastica idonea alla produzione dei giocattoli.”

“Made from a special plastic, suitable for use in toy manufacture.”



Guarda al futuro

Prodotta con plastica idonea all'utilizzo nei giocattoli (direttiva europea EN 71 - 03 e direttiva americana FDA).

Looking to the future
Made of plastic suitable for toy manufacture (according to European standard EN 71-03 and U.S. FDA regulations).



Antibacterial

La plastica è antibatterica, grazie ad uno speciale additivo che sprigiona ioni d'argento impedendo ai batteri di depositarsi sulle superfici della penna.

Antibacterial
It is made of antibacterial plastic containing a special additive which releases silver ions that prevent bacteria from colonising the surface of the pen.

LOVING NATURE

Antibatterica, atossica e sostenibile. Una penna che dura ama la natura.

Antibacterial, non-toxic and sustainable. A pen that lasts is a pen that loves nature.



Vicina all'ambiente

Realizzata con materiali atossici, è stata progettata per durare a lungo nel tempo. Una penna che dura di più inquina di meno perchè rimane a lungo nelle nostre mani, massimizzando la diffusione del logo o del messaggio che porta con sé.

Nature friendly
Made of non-toxic plastics, it has been designed to have a long life and to minimise the risk of harmful substances being released into the environment. Using a pen for as long as possible helps to reduce pollution and enables us to give full expression to the concept of promotion.



Green Chemical

Non contiene: diossina, ftalati, bisfenolo A, antimonio, arsenico, bario, cadmio, cromo, mercurio e piombo ed è conforme alle normative RoHS e REACH. Bifenili polibromurati (PBB), eteri di difenile (PBDE) e deca BDE sono completamente assenti.

Green Chemical
It does not contain dioxin, phthalates, bisphenol A, antimony, arsenic, barium, cadmium, chrome, mercury, lead, polybrominated biphenyls (PBBs), polybrominated diphenyl ethers (PBDEs) or deca-BDE, and conforms to RoHS and REACH directives.



Buona davvero

Le plastiche utilizzate sono conformi alla normativa europea e americana FDA per il contatto alimentare.

Really safe
The plastics employed are compliant with European and American FDA food contact regulations.



Conforme alle regole

La plastica non risulta pericolosa per il CLP (classification, labeling and packaging).

CLP compliant
It is rated as non hazardous pursuant to the Regulation on Classification, Labelling and Packaging.

Tag green

informazioni tecniche

technical information



È possibile combinare particolari di colori diversi della stessa versione (o codice), oppure abbinare elementi di versioni differenti.

You can combine differently coloured parts from the same version (or code number), or elements from different versions.

- A tassello
- B clip
- C fusto
- A plug
- B clip
- C barrel

1/5

CARATTERISTICHE

- meccanismo a rotazione
- realizzata in plastica ABS speciale, ad alta resistenza, atossica e certificata per l'utilizzo nei giocattoli
- antibatterica
- refill X-20, inchiostro blu e nero
- disponibile con superfici lucide

FEATURES

- twist-action
- made of non-toxic, highly resistant special ABS plastic certified for use in toy manufacture
- antibacterial
- X20 refill, blue and black ink
- available in glossy finish

2/5

AREA STAMPABILE

- ① tampografia 45 x 9 mm
- ② tampografia 40 x 9 mm
- ③ serigrafia 40 x 30 mm
- ④ tampografia 8 x 10 mm

PRINT AREA

- ① pad printing 45 x 9 mm
- ② pad printing 40 x 9 mm
- ③ screen printing 40 x 30 mm
- ④ pad printing 8 x 10 mm

3/5

FUSTO

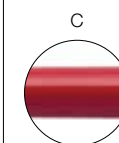

4/5

TASSELLO

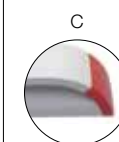

5/5

COLORAZIONI

- colori coprenti speciali



BARREL

PLUG

COLOURS

- special solid colours

MY CASE

Per questo modello è disponibile l'astuccio My case Green in cartoncino FSC in due versioni:

- con testi descrittivi in italiano
- con testi descrittivi in inglese

The My case Green is available in FSC card for this model in two versions:

- with descriptive texts in Italian
- with descriptive texts in English



Tag green TA2 – B

fusto e clip in colore bianco coprente, tassello superiore in colori coprenti, finiture lucide
solid white colour barrel and clip,
solid colours upper plug, glossy finishes

La plastica Green Chemical sprigiona ioni d'argento che svolgono una **funzione antibatterica.**

*Green Chemical plastic releases silver ions that have an **anti-bacterial function.***

01 bianco / tampografia 40 x 9 mm
01 white / pad printing 40 x 9 mm

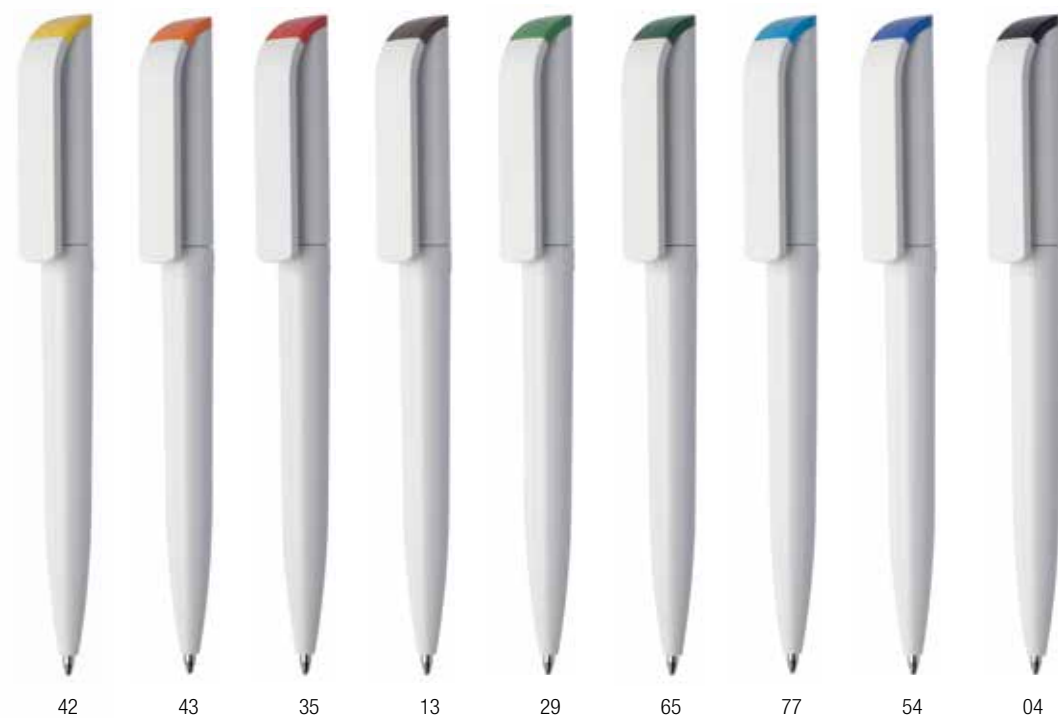

Tag green TA2 – BC

fusto e tassello superiore in colore bianco coprente, clip in colori coprenti, finiture lucide
solid white colour barrel and upper plug,
solid colours clip, glossy finishes

54 blu / tampografia 40 x 9 mm
54 blue / pad printing 40 x 9 mm

29 verde / tampografia 40 x 9 mm
29 green / pad printing 40 x 9 mm



Icon green

nel rispetto dell'uomo e della natura
people and environment friendly



**Testimone di un
messaggio destinato
a durare nel tempo.**

Testimony of an enduring message.

“Un significativo passo avanti nella sicurezza della plastica.”

“A significant step forward toward the use of safe plastic.”



Vicina all'ambiente

Realizzata con materiali atossici, è stata progettata per durare a lungo nel tempo. **Una penna che dura di più inquina di meno** perchè rimane a lungo nelle nostre mani, massimizzando la diffusione del logo o del messaggio che porta con sé.

Nature friendly

Made of non-toxic plastics, it has been designed to have a long life and to minimise the risk of harmful substances being released into the environment. **Using a pen for as long as possible helps to reduce pollution** and enables us to give full expression to the concept of promotion.



Green Chemical

Non contiene: diossina, ftalati, bisfenolo A, antimonio, arsenico, bario, cadmio, cromo, mercurio e piombo ed è **conforme alle normative RoHS e REACH**. Bifenili polibromurati (PBB), eteri di difenile (PBDE) e deca BDE **sono completamente assenti**.

Green Chemical

It does not contain dioxin, phthalates, bisphenol A, antimony, arsenic, barium, cadmium, chrome, mercury, lead, polybrominated biphenyls (PBBs), polybrominated diphenyl ethers (PBDEs) or deca-BDE, and conforms to RoHS and REACH directives.

LOVING NATURE

Antibatterica, atossica e sostenibile. Una penna che dura ama la natura.

Antibacterial, non-toxic and sustainable. A pen that lasts is a pen that loves nature.



Guarda al futuro

Prodotta con plastica idonea all'utilizzo nei giocattoli (direttiva europea EN 71 - 03 e direttiva americana FDA).

Looking to the future

Made of plastic suitable for toy manufacture (according to European standard EN 71-03 and U.S. FDA regulations).



Antibacterial

La plastica è antibatterica, grazie ad uno speciale additivo che sprigiona ioni d'argento impedendo ai batteri di depositarsi sulle superfici della penna.

Antibacterial

It is made of antibacterial plastic containing a special additive which releases silver ions that prevent bacteria from colonising the surface of the pen.



Buona davvero

Le plastiche utilizzate sono **conformi alla normativa europea e americana FDA per il contatto alimentare**.

Really safe

The plastics employed are compliant with European and American FDA food contact regulations.



Conforme alle regole

La plastica non risulta pericolosa per il CLP (classification, labeling and packaging).

CLP compliant

It is rated as **non hazardous** pursuant to the Regulation on Classification, Labelling and Packaging.



Icon green

informazioni tecniche

technical information



È possibile combinare particolari di colori diversi della stessa versione (o codice), oppure abbinare elementi di versioni differenti.

You can combine differently coloured parts from the same version (or code number), or elements from different versions.

A cappuccio

B fusto

A cap

B barrel

1/5

CARATTERISTICHE

- meccanismo a rotazione
- realizzata in plastica ABS speciale, ad alta resistenza, atossica e certificata per l'utilizzo nei giocattoli
- antibatterica
- refill X20, inchiostro blu e nero
- disponibile con superfici lucide

FEATURES

- twist-action
- made of non-toxic, highly resistant special ABS plastic certified for use in toy manufacture
- antibacterial
- X20 refill, blue and black ink
- available in glossy finish

2/5

AREA STAMPABILE

- 1 tampografia 45 x 9 mm
- 2 tampografia 35 x 7 mm
- 3 serigrafia 40 x 30 mm

PRINT AREA

- 1 pad printing 45 x 9 mm
- 2 pad printing 35 x 7 mm
- 3 screen printing 40 x 30 mm

3/5

FUSTO

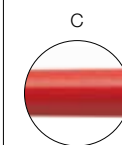

4/5

CAPPUCCIO

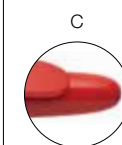

5/5

COLORAZIONI

- colori coprenti speciali



BARREL

CAP

COLOURS

- special solid colours

MY CASE

Per questo modello è disponibile l'astuccio My case Green in cartoncino FSC in due versioni:

- con testi descrittivi in italiano
- con testi descrittivi in inglese

The My case Green is available in FSC card for this model in two versions:

- with descriptive texts in Italian
- with descriptive texts in English



Icon green IG2 – BC

fusto in colore bianco coprente,
cappuccio in colori coprenti, finiture lucide
solid white colour barrel, solid colours cap,
glossy finishes

35 rosso / tampografia 35 x 7 mm
35 red / pad printing 35 x 7 mm



42

43



**Realizzata con una
plastica speciale idonea
alla produzione
di giocattoli.**

*Made of special plastic used
to manufacture children's toys.*



29 verde / tampografia 35 x 7 mm
29 green / pad printing 35 x 7 mm



13



65



54



04

Icon green IG2 – C

colori solidi con finitura lucida
solid colours with glossy finish

65 verde scuro / tampografia 35 x 7 mm
65 dark green / pad printing 35 x 7 mm

01 bianco / tampografia 35 x 7 mm
01 white / pad printing 35 x 7 mm



70



42



43



35



13



29



54



04

Ethic

eleganza e flessibilità
elegance and flexibility



**Costruita a misura
di cliente.**

Tailored to the customer's requirements.

Ethic

informazioni tecniche

technical information



È possibile combinare particolari di colori diversi della stessa versione (o codice), oppure abbinare elementi di versioni differenti.

You can combine differently coloured parts from the same version (or code number), or elements from different versions.

- | | |
|---------------|---------------|
| ● A tappino | ● A small cap |
| ● B cappuccio | ● B cap |
| ● C anelli | ● C rings |
| ● D fusto | ● D barrel |
| ● E punta | ● E tip |

1/4

CARATTERISTICHE

- meccanismo a rotazione
- realizzata in plastica ABS, atossica e ad alta resistenza
- clip in metallo, con finitura cromata, dorata o verniciata color alluminio
- la cromatura e la doratura delle parti in ABS sono ottenute con un trattamento galvanico
- refill Jumbo, inchiostro blu e nero
- disponibile con superfici lucide o verniciate in colori metallizzati o alluminio

FEATURES

- twist-action
- made of non-toxic, highly resistant ABS plastic
- metal clip with chrome, gilded or aluminium painted finish
- galvanic process used to chrome or to gild ABS parts
- Jumbo refill, blue and black ink
- available in glossy and metallic or aluminium painted finish

2/4

AREA STAMPABILE

- 1 tampografia 30 x 8 mm
- 2 serigrafia 45 x 30 mm
- 3 tampografia 55 x 9,5 mm

PRINT AREA

- 1 pad printing 30 x 8 mm
- 2 screen printing 45 x 30 mm
- 3 pad printing 55 x 9,5 mm

3/4

FUSTO

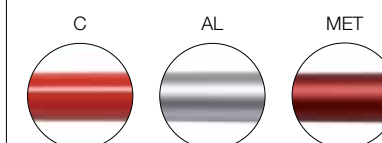

BARREL

PUNTA E ANELLI

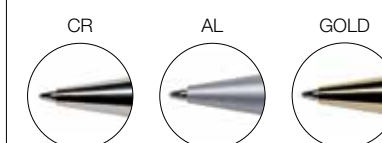

TIP AND RINGS



4/4

COLORAZIONI

- coprenti
- 01 70 03 18 15 74 25 09 75
- vernici metallizzate
- 91 92 83 85 81 82 89 94 95
- trattamento galvanico
- ●

COLOURS

- solid
- 27 12 22 04
- metallic paintings
- 96 ●
- galvanic process

Ethic

ET900 – MULTICOLOUR

colori coprenti con finitura lucida,
clip in metallo cromato, punta cromata
solid colours with glossy finish, metal
chrome finish clip, chromed tip

**Pensata per durare
oltre le mode del
momento, come il
messaggio che deve
trasmettere.**

*Designed to outlast passing fashions,
like the message it conveys.*



18



R

09



G verde / tampografia 55 x 9,5 mm
G green / pad printing 55 x 9,5 mm

12



B

Ethic

ET900 – FLAG

colori coprenti con finitura lucida,
clip in metallo cromato, punta cromata
solid colours with glossy finish, metal
chrome finish clip, chromed tip



22



FR

15



SP

04



GE

09



IT / tampografia 55 x 9,5 mm
IT / pad printing 55 x 9,5 mm

ET900 – C FLAG

colori coprenti con finitura lucida,
clip in metallo cromato, punta cromata
solid colours with glossy finish, metal
chrome finish clip, chromed tip



01



22 IT

01



04 IT / tampografia 55 x 9,5 mm
04 IT / pad printing 55 x 9,5 mm

Ethic ET900 – B

colori coprenti con finitura lucida,
clip in metallo cromato, punta cromata
solid colours with glossy finish, metal
chrome finish clip, chromed tip

**Punta, fusto, cappuccio, tappino
e 3 anelli disponibili in una ricca
gamma di colori: più di 300
milioni di combinazioni possibili!**

*Tip, barrel, cap, push-button and 3 rings
available in a vast range of colours: more
than 300 million combinations possible!*



03



03

15



15

74



74

25



25

09



09

12



12

22



22

18



18 arancio / tampografia 55 x 9,5 mm
18 orange / pad printing 55 x 9,5 mm

04



04 nero / tampografia 55 x 9,5 mm
04 black / pad printing 55 x 9,5 mm

Ethic ET900 – BC

colori coprenti con finitura lucida,
clip in metallo cromato, due anelli
e punta cromati, tappino bianco
solid colours with glossy finish,
metal chrome finish clip, white
top, chromed tip and two rings



01



15 rosso / tampografia 30 x 8 mm
15 red / pad printing 30 x 8 mm

serigrafia 45 x 30 mm
screen printing 45 x 30 mm

01



70

01



03

01



18

01



74

01



09

01



27

01



12

01



22

01



04

Ethic

ET900 – C CR

colori coprenti con finitura lucida, clip in metallo cromato, due anelli, punta e tappino cromati
solid colours with glossy finish, metal chrome finish clip, chromed tip, top and two rings



03 giallo / tampografia 55 x 9,5 mm
03 yellow / pad printing 55 x 9,5 mm

74 bordeaux / tampografia 55 x 9,5 mm
74 burgundy / pad printing 55 x 9,5 mm

ET900 – C GOLD

colori coprenti con finitura lucida, clip in metallo dorato, due anelli, punta e tappino dorati
solid colours with glossy finish, gilded metal finish clip, gilded tip, top and two rings

I dettagli, cromati o dorati, ne esaltano l'eleganza.

The chrome or gilded details enhance the pen's elegance.



01 bianco / serigrafia 45 x 30 mm
01 white / screen printing 45 x 30 mm

Ethic

ET900 – AL

fusto, cappuccio e anello centrale verniciati in colore alluminio, due anelli e tappino in colore coprente con finitura lucida, clip in metallo cromato, punta cromata
aluminium painted finish barrel, cap and central ring, solid colour two rings and top with glossy finish, metal chrome finish clip, chromed tip



Ethic

ET900 – AL CR

fusto, cappuccio e anello centrale verniciati in colore alluminio, clip in metallo cromato, due anelli, tappino e punta cromati
aluminium painted finish barrel, cap and central ring, metal chrome finish clip, chromed tip, top, and two rings

chrome



Design raffinato e flessibile, per i brand più esigenti.

Refined, flexible design for the most demanding brands.

ET900 – AL FLAG

fusto e cappuccio verniciati in colore alluminio, anelli e tappino in colori coprenti con finitura lucida, clip in metallo cromato, punta cromata
aluminium painted finish barrel and cap, solid colour rings with glossy finish, metal chrome finish clip, chromed tip

09



IT

Ethic

ET900 – MET CR

fusto, cappuccio e anello centrale verniciati in colori metallizzati, clip in metallo cromato, due anelli, tappino e punta cromati
 metallic colour painted finish barrel, cap and central ring, metal chrome finish clip, chromed tip, top and two rings



Ethic

ET900 – MET AL

fusto, cappuccio e anello centrale verniciati in colori metallizzati, clip in metallo verniciato in colore alluminio, due anelli, tappino e punta verniciati in colore alluminio
 metallic colour painted finish barrel, cap and central ring, metal aluminium painted finish clip, aluminium painted finish tip, top and two rings



Next

la forma che verrà
the shape for the future



**Scattante e dinamica:
l'accelerazione positiva
per ogni brand.**

*Sleek, dynamic lines, able to boost
the visibility and identity of every brand.*

Next
informazioni
tecniche
technical
information

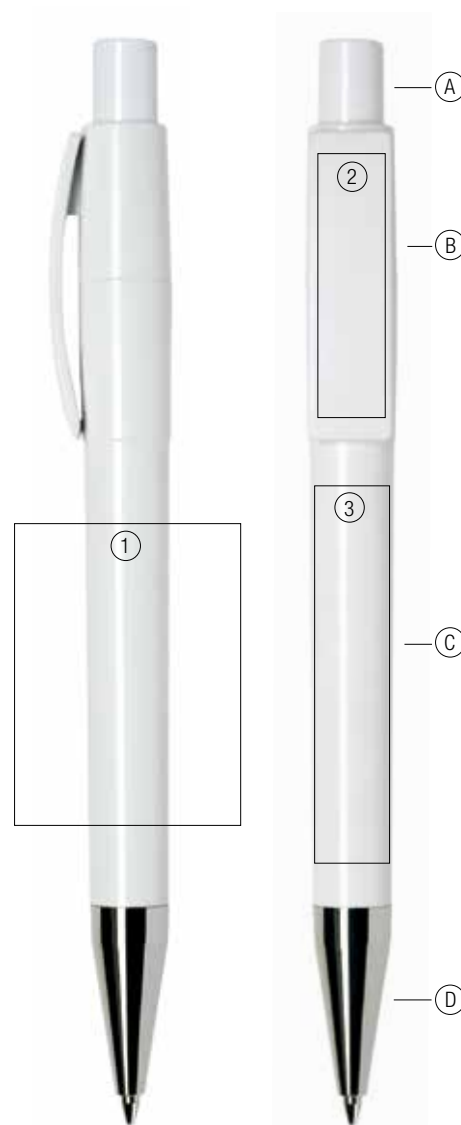

- | | |
|-----------|---------------|
| Ⓐ tappino | Ⓐ push-button |
| Ⓑ clip | Ⓑ clip |
| Ⓒ fusto | Ⓒ barrel |
| Ⓓ punta | Ⓓ tip |

È possibile combinare particolari di colori diversi della stessa versione (o codice), oppure abbinare elementi di versioni differenti.

You can combine differently coloured parts from the same version (or code number), or elements from different versions.

1/5

CARATTERISTICHE

- meccanismo a scatto, con molla di ritorno
- tappino ventilato
- realizzata in plastica ABS, atossica e ad alta resistenza
- refill Jumbo, inchiostro blu e nero
- il fusto è disponibile con superfici lucide, satinare, gommate o verniciate con colori metallizzati o alluminio
- la cromatura della punta in ABS è ottenuta con trattamento galvanico
- le versioni NX 400 - GOM C CR e NX 400 - GOM AL sono stampabili solo sulla clip

FEATURES

- retractable with return spring
- ventilated push-button
- made of non-toxic, highly resistant ABS plastic
- Jumbo refill, blue and black ink
- the barrel is available in glossy, matt, rubberised and metallic or aluminium painted finish
- galvanic process used to chrome the ABS tip
- the NX 400 - GOM C CR and NX 400 - GOM AL versions are only printable on the clip

2/5

AREA STAMPABILE

- ① serigrafia 40 x 30 mm
- ② tampografia 35 x 9 mm
- ③ tampografia 50 x 10 mm

PRINT AREA

- ① screen printing 40 x 30 mm
- ② pad printing 35 x 9 mm
- ③ pad printing 50 x 10 mm

3/5

FUSTO



BARREL

4/5

PUNTA E TAPPINO

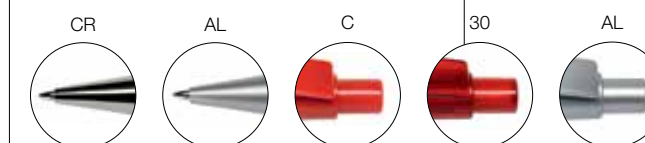

TIP AND PUSH-BUTTON

5/5

COLORAZIONI

- coprenti
- ① 01 70 03 18 15 74 09 12 22 04
- trasparenti
- ② 39 52 53 45 51 55 49 47 44 40
- vernici metallizzate
- 92 83 85 94 95 96
- trattamento galvanico

COLOURS

- solid
- transparent
- metallic paintings
- galvanic process

Next

NX400 – C CR

colori coprenti con finitura lucida, punta cromata
solid colours with glossy finish, chromed tip



70 03 18 15 74 09 12 22

04 nero / tampografia 50 x 10 mm
04 black / pad printing 50 x 10 mm



01 bianco / tampografia 50 x 10 mm
01 white / pad printing 50 x 10 mm

Next

NX400 – 30 CR

colori trasparenti con finitura lucida, punta cromata
transparent colours with glossy finish, chromed tip



39 52 53 45 55 49 44 40

47 acquamarina / tampografia 35 x 9 mm
47 aquamarine / pad printing 35 x 9 mm



51 viola / tampografia 35 x 9 mm
51 violet / pad printing 35 x 9 mm



Next

NX400 – FROST AL

fusto in colore trasparente con finitura satinata, clip,
tappino e punta verniciati in colore alluminio
transparent colour barrel with matt finish,
aluminium painted finish clip, push-button and tip

**La clip: uno schermo
su cui trasmettere
l'immagine di un brand.**

*The clip: a screen
for conveying brand image.*

44 blu / tampografia 35 x 9 mm
44 blue / pad printing 35 x 9 mm

49 verde / tampografia 35 x 9 mm
49 green / pad printing 35 x 9 mm



Next

NX400 – MET AL

fusto verniciato in colori metallizzati, clip,
tappino e punta verniciati in colore alluminio
metallic colours painted finish barrel, aluminium
painted finish clip, push-button and tip

NX400 – AL CR

verniciatura in colore alluminio, punta cromata
aluminium painted finish, chromed tip

alluminio / tampografia 35 x 9 mm
aluminium / pad printing 35 x 9 mm

85 rosso / tampografia 50 x 10 mm
85 red / pad printing 50 x 10 mm



Next

NX400 – GOM C CR

fusto in colore coprente gommato, clip e tappino
in colori coprenti con finitura lucida, punta cromata
solid colour barrel with rubber finish, solid colour
clip and push-button with glossy finish, chromed tip



74 bordeaux / tampografia 35 x 9 mm
74 burgundy / pad printing 35 x 9 mm

03

18

15

09



12 azzurro / tampografia 35 x 9 mm
12 light blue / pad printing 35 x 9 mm



22

04

Next

NX400 – GOM AL

fusto in colore coprente gommato, clip,
tappino e punta verniciati in colore alluminio
solid colour barrel with rubber finish, aluminium
painted finish clip, push-button and tip



03 giallo / tampografia 35 x 9 mm
03 yellow / pad printing 35 x 9 mm



18

15

74



09 verde / tampografia 35 x 9 mm
09 green / pad printing 35 x 9 mm



12

22

04

**Il tappino è ventilato
per garantire
sufficiente passaggio
di aria in caso
di ingestione.**

*The ventilated push-button
ensures sufficient airflow
if inadvertently swallowed.*

Pixel

il design ad alta definizione
high resolution design



**Sintesi dello stile
contemporaneo.**

A synthesis of contemporary style.

Pixel
informazioni
tecniche
*technical
information*

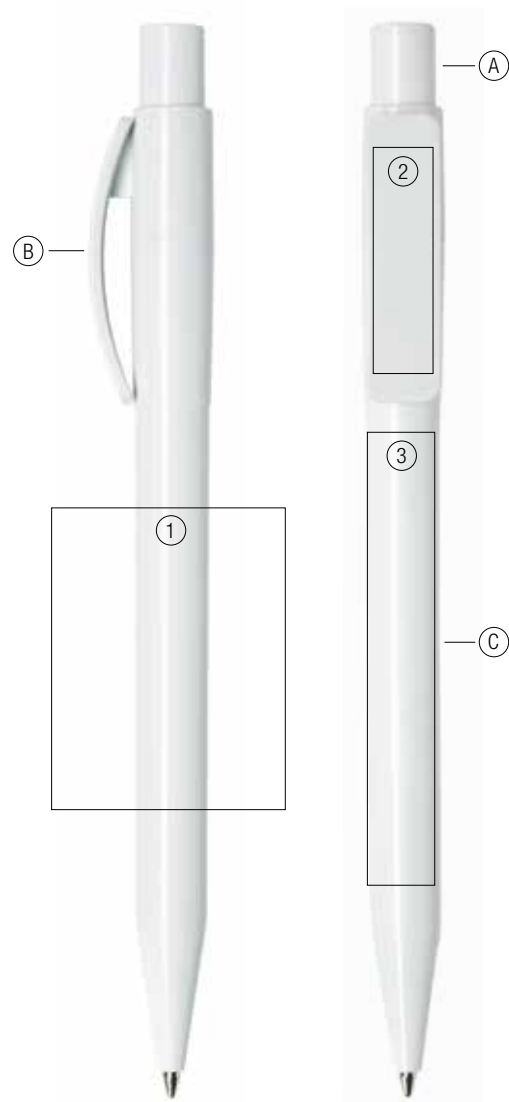

**Vai su maxema.com
per scegliere i tuoi
colori preferiti.**

*Go to maxema.com to choose
your favourite colours.*

- Ⓐ tappino Ⓐ push-button
- Ⓑ clip Ⓑ clip
- Ⓒ fusto Ⓒ barrel

1/5

CARATTERISTICHE

- meccanismo a scatto
- tappino ventilato
- realizzata in plastica ABS, atossica e ad alta resistenza
- refill X 20, inchiostro blu e nero
- il fusto è disponibile con superfici lucide, satinare o gommate
- la cromatura del tappino in ABS è ottenuta con trattamento galvanico
- le versioni PX 40 - GOM C CR e PX 40 - GOM 30 CR sono stampabili solo sulla clip

FEATURES

- retractable
- ventilated push-button
- made of non-toxic, highly resistant ABS plastic
- X-20 refill, blue and black ink
- the barrel is available in glossy, matt or rubberised finish
- galvanic process used to chrome the ABS push-button
- the PX 40 - GOM C CR and PX 40 - GOM 30 CR versions are only printable on the clip

2/5

AREA STAMPABILE

- ① serigrafia 40 x 31 mm
- ② tampografia 30 x 8 mm
- ③ tampografia 60 x 9 mm

PRINT AREA

- ① screen printing 40 x 31 mm
- ② pad printing 30 x 8 mm
- ③ pad printing 60 x 9 mm

3/5

FUSTO

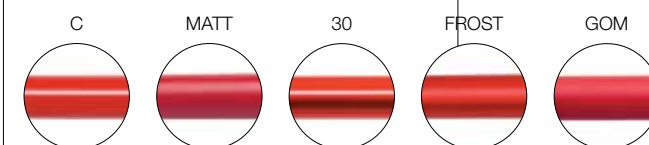

BARREL

4/5

TAPPINO

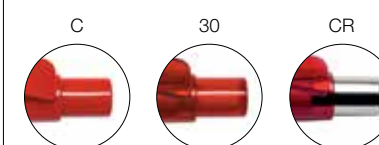

PUSH-BUTTON

5/5

COLORAZIONI

- coprenti
- ① 01 70 03 18 15 74 60 61 71
- trasparenti
- ① 39 52 53 45 41 51 55 49 47
- trattamento galvanico

COLOURS

- solid
- 25 73 79 09 75 26 27 64 77 12 22 05 04
- transparent
- 44 40 50
- galvanic process

Pixel

PX40 – B

fusto e tappino in colore bianco coprente,
clip in colori coprenti, finiture lucide
solid white colour barrel and push-button,
solid colours clip, glossy finishes

22 blu / tampografia 30 x 8 mm
22 blue / pad printing 30 x 8 mm

74 bordeaux / tampografia 30 x 8 mm
74 burgundy / pad printing 30 x 8 mm



Pixel

PX40 – C

colori coprenti con finitura lucida
solid colours with glossy finish

09 verde / tampografia 30 x 8 mm
09 green / pad printing 30 x 8 mm



04 nero / tampografia 30 x 8 mm
04 black / pad printing 30 x 8 mm



Pixel PX40 – MATT CB

fusto in colore coprente con finitura satinata,
clip e tappino in colore bianco coprente lucido
solid colour barrel with matt finish, solid glossy
white colour clip and push-button

NEW

61 magenta / tampografia 30 x 8 mm
61 magenta / pad printing 30 x 8 mm

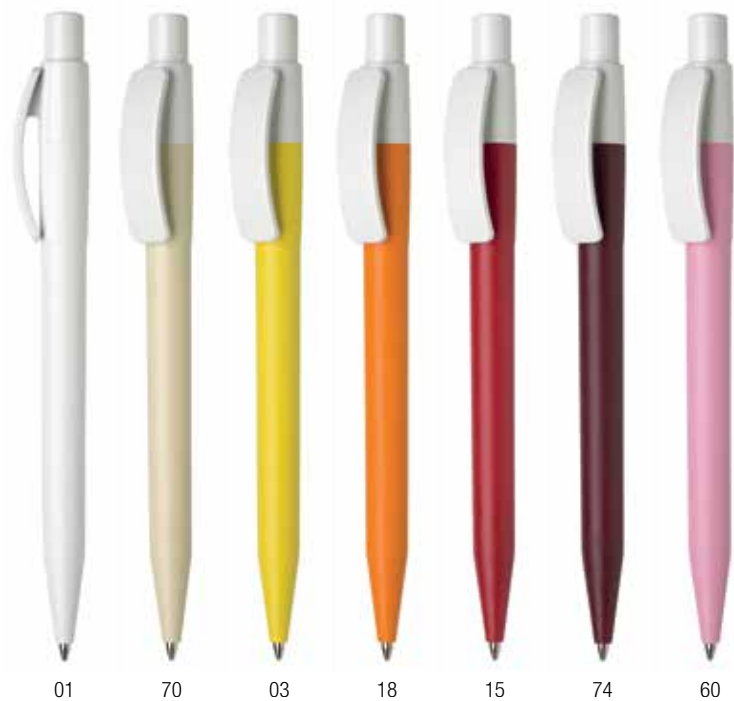

Colori con finitura matt e clip bianca: una nuova combinazione facile e grintosa.

*Colours with matt finish and white clip:
an easy, gritty new combination.*

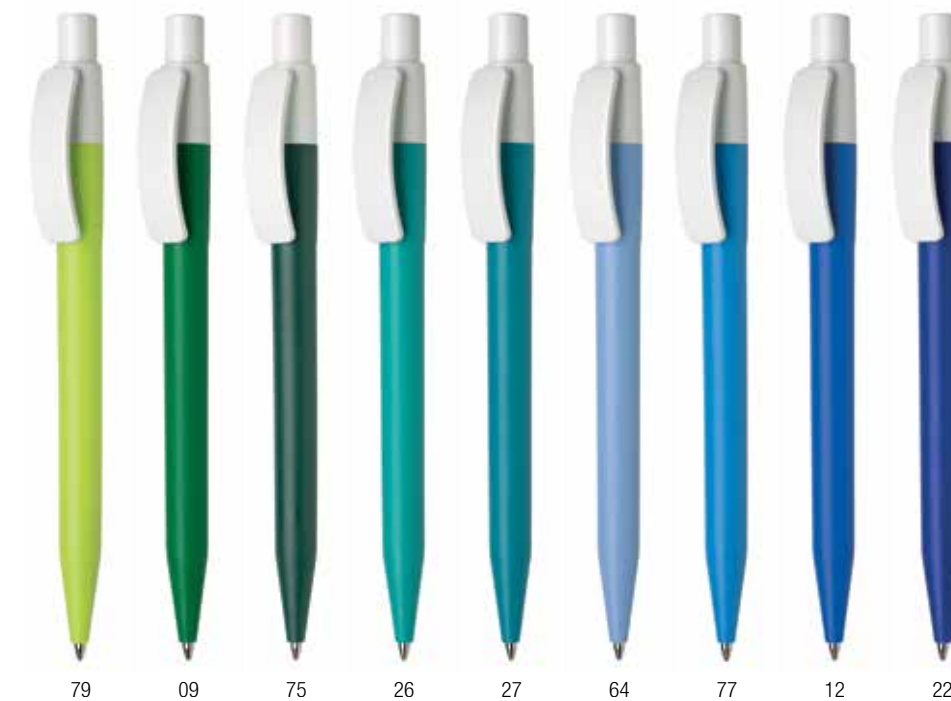

05 grigio / tampografia 30 x 8 mm
05 grey / pad printing 30 x 8 mm



Pixel

PX40 – MATT CR

fusto in colore coprente con finitura satinata,
clip in colore coprente lucido, tappino cromato
solid colour barrel with matt finish, solid glossy
colour clip, chromed push-button



Pixel

PX40 – B 30

fusto in colore bianco coprente lucido, clip e tappino in colori trasparenti con finitura lucida
solid glossy white colour barrel, transparent colour clip and push button with glossy finish

51 viola / tampografia 30 x 8 mm
51 violet / pad printing 30 x 8 mm



40 grigio / tampografia 30 x 8 mm
40 grey / pad printing 30 x 8 mm



Pixel

PX40 – 30

colori trasparenti con finitura lucida
transparent colours with glossy finish

Design dai tratti essenziali: uno strumento grintoso per brand dinamici.

*Design with basic features:
a feisty pen for dynamic brands.*

47 acquamarina / tampografia 30 x 8 mm
47 aquamarine / pad printing 30 x 8 mm



45 rosso / tampografia 30 x 8 mm
45 red / pad printing 30 x 8 mm



Pixel

PX40 – FROST NEUTRAL

colori trasparenti, fusto con finitura satinata,
clip e tappino con finitura lucida
transparent colours, matt finish barrel,
glossy finish clip and push-button

**Il tappino ventilato
è conforme alle
normative CEE sui
piccoli componenti.**

*The ventilated push-button is compliant
with EU laws for small components.*

55 viola scuro / tampografia 30 x 8 mm
55 dark violet / pad printing 30 x 8 mm



53 arancio / tampografia 30 x 8 mm
53 orange / pad printing 30 x 8 mm

Pixel

PX40 – FROST

colori trasparenti, fusto con finitura satinata,
clip e tappino con finitura lucida
transparent colours, matt finish barrel,
glossy finish clip and push-button

44 blu / tampografia 30 x 8 mm
44 blue / pad printing 30 x 8 mm



51 viola / tampografia 30 x 8 mm
51 violet / pad printing 30 x 8 mm

tampografia 60 x 9 mm
pad printing 60 x 9 mm



Pixel

PX40 – GOM C CR

fusto in colore coprente gommato, clip in colore
coprente con finitura lucida, tappino cromato
solid colour barrel with rubber finish, solid colour
clip with glossy finish, chromed push-button

04 nero / tampografia 30 x 8 mm
04 black / pad printing 30 x 8 mm

15 rosso / tampografia 30 x 8 mm
15 red / pad printing 30 x 8 mm



Pixel

PX40 – GOM 30 CR

fusto in colore coprente gommato, clip in colore
trasparente con finitura lucida, tappino cromato
solid colour barrel with rubber finish, transparent
colour clip with glossy finish, chromed push-button

47 acquamarina / tampografia 30 x 8 mm
47 aquamarine / pad printing 30 x 8 mm



41 magenta / tampografia 30 x 8 mm
41 magenta / pad printing 30 x 8 mm

Bay

disinvolta e accattivante
casual and attractive



**Attrae per
la sua semplicità.**

Draws attention for its simplicity.

Bay
informazioni
tecniche
*technical
information*

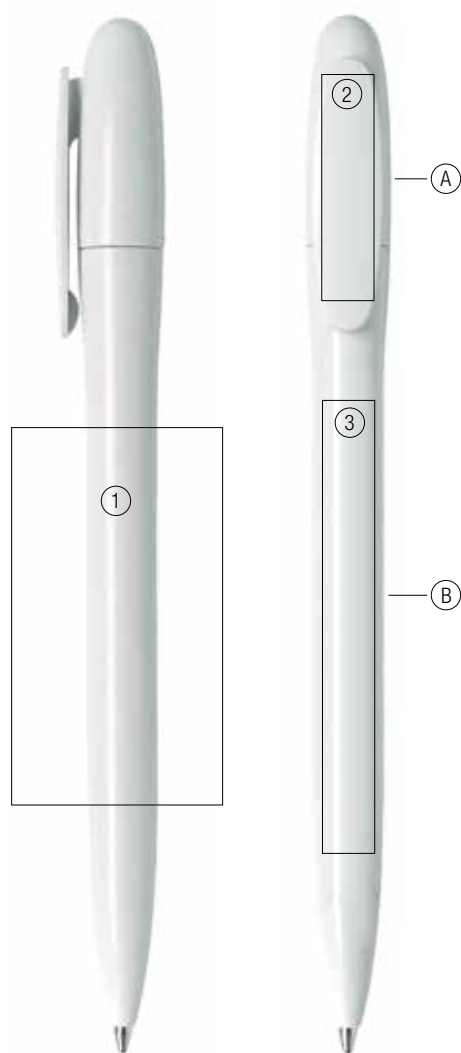

- Ⓐ cappuccio Ⓐ cap
- Ⓑ fusto Ⓑ barrel

**Vai su maxema.com
per scegliere i tuoi
colori preferiti.**

*Go to maxema.com to choose
your favourite colours.*

1/4

CARATTERISTICHE

- meccanismo a rotazione
- realizzata in plastica ABS, atossica e ad alta resistenza
- refill X-20, inchiostro blu e nero
- disponibile con superfici lucide o satinare

FEATURES

- twist-action
- made of non-toxic, highly resistant ABS plastic
- X-20 refill, blue and black ink
- available in glossy or matt finish

2/4

AREA STAMPABILE

- ① serigrafia 50 x 28 mm
- ② tampografia 30 x 7 mm
- ③ tampografia 60 x 7 mm

PRINT AREA

- ① screen printing 50 x 28 mm
- ② pad printing 30 x 7 mm
- ③ pad printing 60 x 7 mm

3/4

FUSTO

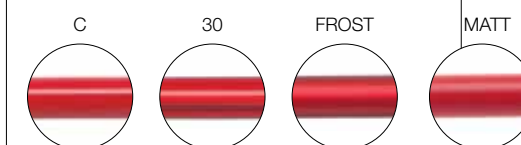

BARREL

CAPPUCCIO

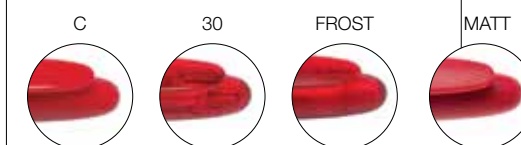

CAP

4/4

COLORAZIONI

- coprenti
- ① 01 70 03 18 15 74 60 61 71
- trasparenti
- ① 39 52 53 45 51 55 49 47 44

COLOURS

- solid
- 25 73 79 09 75 26 27 64 77 12 22 05 04
- transparent
- 40

Bay B500 – MATT BC

fusto in colore bianco coprente, cappuccio
in colori coprenti, finiture satinare
solid white colour barrel, solid colours cap,
matt finishes



60 rosa / tampografia 30 x 7 mm
60 pink / pad printing 30 x 7 mm



75 verde scuro / tampografia 30 x 7 mm
75 dark green / pad printing 30 x 7 mm

tampografia 60 x 7 mm
pad printing 60 x 7 mm

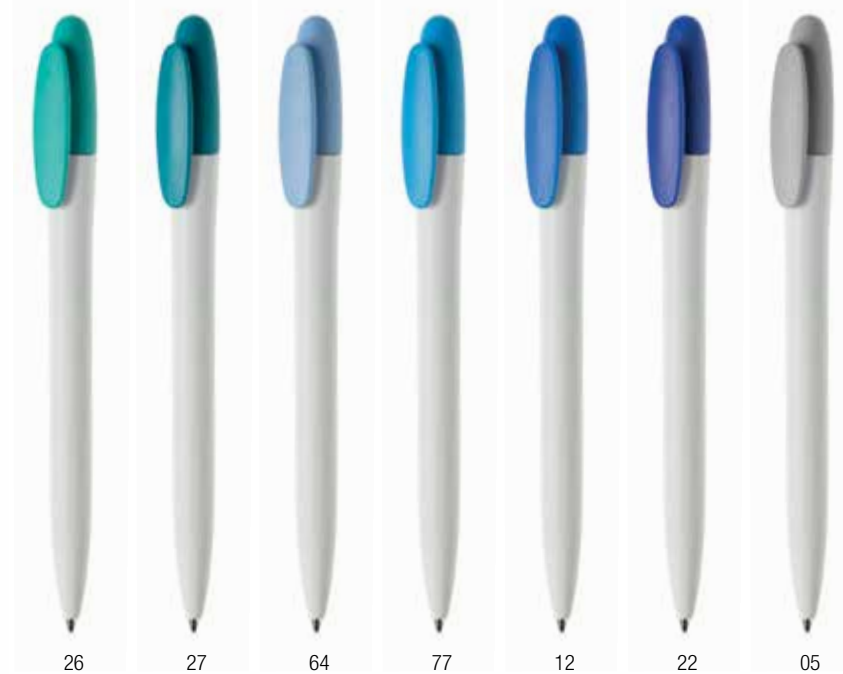

04 nero / tampografia 60 x 7 mm
04 black / pad printing 60 x 7 mm



Bay

B500 – MATT

colori coprenti con finitura satinata
solid colours with matt finish

73 marrone / tampografia 60 x 7 mm
73 brown / pad printing 60 x 7 mm



**Effetto satinato:
raffinata delicatezza
declinabile in 22 colori.**

Delicately refined matt finish in 22 colours.



01 bianco / tampografia 30 x 7 mm
01 white / pad printing 30 x 7 mm



27 ottanio / tampografia 30 x 7 mm
27 octan green / pad printing 30 x 7 mm

Bay B500 – BC

fusto in colore bianco coprente,
cappuccio in colori coprenti, finiture lucide
solid white colour barrel, solid colours cap,
glossy finishes

22 blu / tampografia 60 x 7 mm
22 blue / pad printing 60 x 7 mm



Bay B500 – C

colori coprenti con finitura lucida
solid colours with glossy finish

04 nero / tampografia 30 x 7 mm
04 black / pad printing 30 x 7 mm

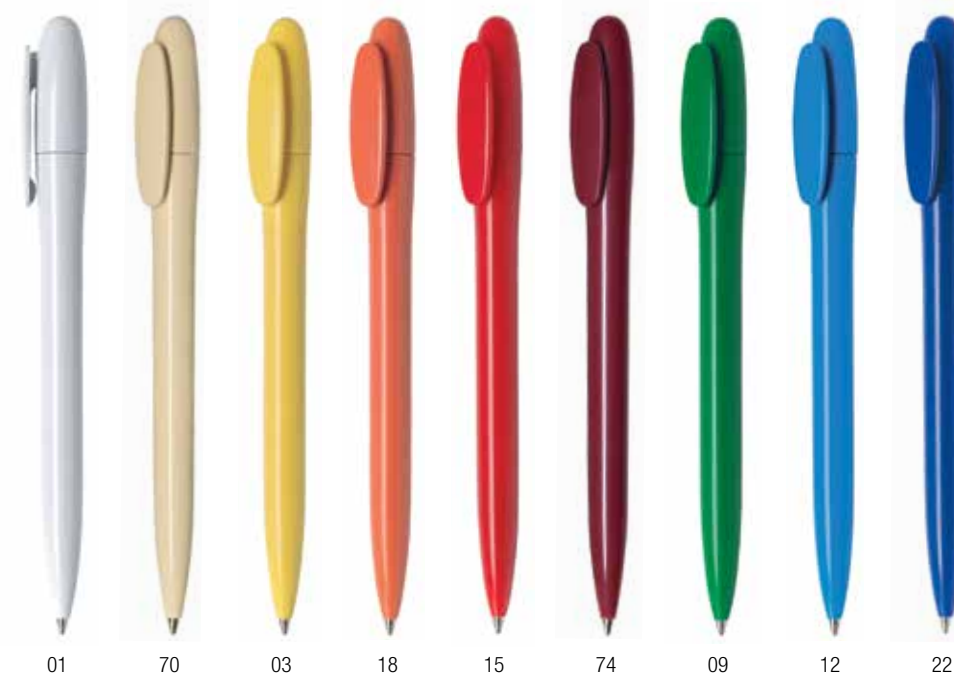

Bay B500 – 30

colori trasparenti con finitura lucida
transparent colours with glossy finish

47 acquamarina / tampografia 30 x 7 mm
47 aquamarine / pad printing 30 x 7 mm



39 52 53



51 55 49

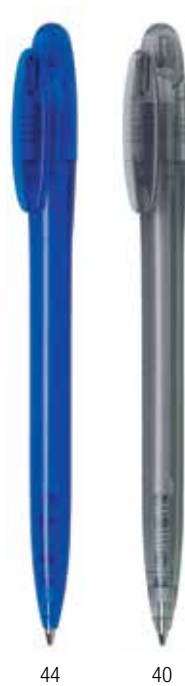

44 40

45 rosso / tampografia 30 x 7 mm
45 red / pad printing 30 x 7 mm



Bay B500 – FROST

colori trasparenti con finitura satinata
transparent colours with matt finish

55 viola scuro / tampografia 30 x 7 mm
55 dark violet / pad printing 30 x 7 mm



52 53 45 51



49 44 40

39 neutro / tampografia 60 x 7 mm
39 neutral / pad printing 60 x 7 mm

Soft

design innovativo dal morbido profilo
an innovative design and a soft profile



**Linearità e comfort
di scrittura.**

Linear design and a comfortable writing position.

Soft
informazioni
tecniche
*technical
information*

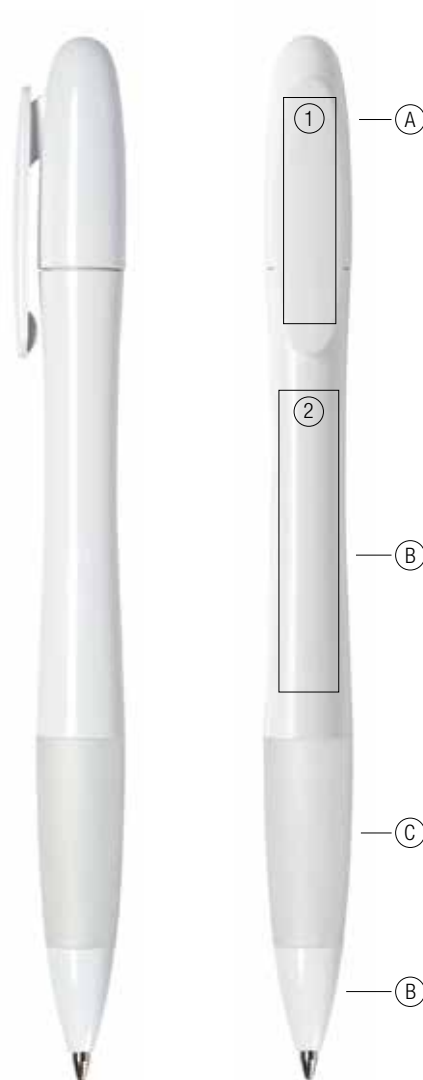

È possibile combinare particolari di colori diversi della stessa versione (o codice), oppure abbinare elementi di versioni differenti.

You can combine differently coloured parts from the same version (or code number), or elements from different versions.

- | | |
|-------------------|------------------|
| ● A cappuccio | ● A cap |
| ● B fusto / punta | ● B barrel / tip |
| ● C gomma | ● C rubber |

1/5

CARATTERISTICHE

- meccanismo a rotazione
- realizzata in plastica ABS, atossica e ad alta resistenza
- impugnatura in gomma termoplastica
- refill X-20, inchiostro blu e nero
- disponibile con superfici lucide o verniciate in colore alluminio

FEATURES

- twist-action
- made of non-toxic, highly resistant ABS plastic
- grip in thermoplastic rubber
- X-20 refill, blue and black ink
- available in glossy or aluminium colour painted finish

2/5

AREA STAMPABILE

- 1 tampografia 30 x 7 mm
- 2 tampografia 40 x 8 mm

PRINT AREA

- 1 pad printing 30 x 7 mm
- 2 pad printing 40 x 8 mm

3/5

FUSTO

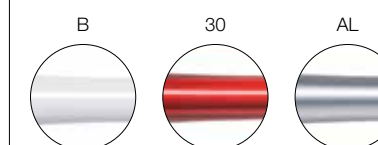

BARREL

4/5

PUNTA

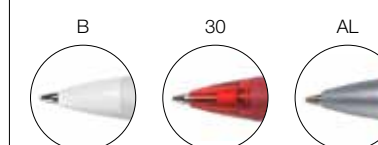

TIP

5/5

COLORAZIONI

- trasparenti
- vernici metallizzate



COLOURS

- transparent
- metallic paintings

Soft S90 – B

colore bianco coprente con finitura lucida,
impugnatura in gomma termoplastica colorata
solid white colour with glossy finish, grip
in coloured thermoplastic rubber

51 viola / tampografia 40 x 8 mm
51 violet / pad printing 40 x 8 mm



**La gomma
garantisce
un effetto grip.**

Rubber for non-slip grip.



Soft S90 – B 30

fusto colore bianco coprente con finitura lucida, cappuccio in colore trasparente
con finitura lucida, impugnatura in gomma termoplastica colorata
solid white colour barrel with glossy finish, transparent colour
cap with glossy finish, grip in coloured thermoplastic rubber

40 grigio / tampografia 40 x 8 mm
40 grey / pad printing 40 x 8 mm



45 rosso / tampografia 40 x 8 mm
45 red / pad printing 40 x 8 mm



Soft S90 – 30

colori trasparenti con finitura lucida,
impugnatura in gomma termoplastica colorata
transparent colours with glossy finish,
grip in coloured thermoplastic rubber

**Forma sinuosa che
non passa inosservata.**

*Sinuous shape that is sure
to catch attention.*



55 viola scuro / tampografia 30 x 7 mm
55 dark violet / pad printing 30 x 7 mm

Soft S90 – AL 30

fusto verniciato in colore alluminio, cappuccio in colori trasparenti
con finitura lucida, impugnatura in gomma termoplastica colorata
aluminium colour barrel, transparent colour cap
with glossy finish, grip in coloured thermoplastic rubber

40 grigio / tampografia 30 x 7 mm
40 grey / pad printing 30 x 7 mm



39 neutro / tampografia 40 x 8 mm
39 neutral / pad printing 40 x 8 mm



Polo

armonia di forme e di spazi
harmony of form and space



**Equilibrio di linee
decise e curve delicate.**

*A perfect balance of bold
styling and soft curves.*

Polo

informazioni tecniche

technical information

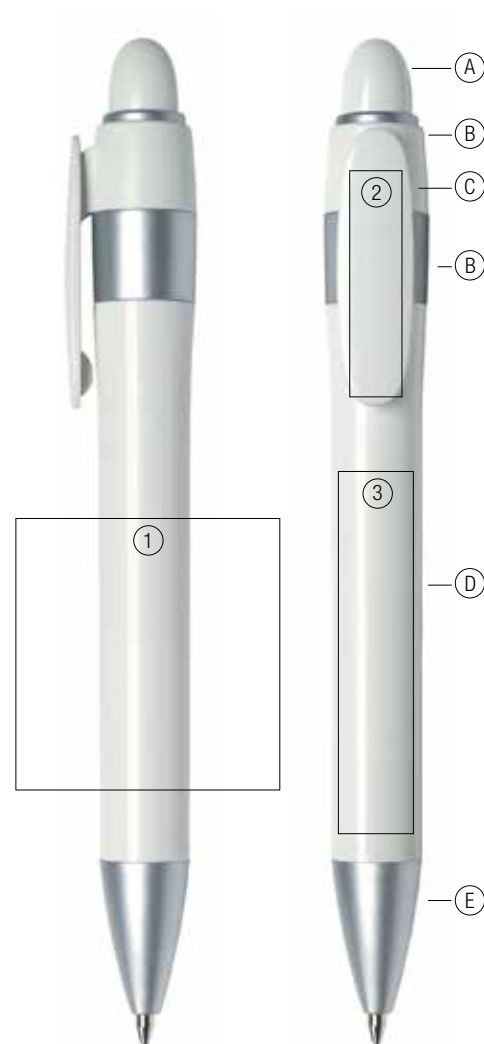

- | | |
|------------|---------------|
| Ⓐ tappino | Ⓐ push-button |
| Ⓑ raccordo | Ⓑ joint trim |
| Ⓒ clip | Ⓒ clip |
| Ⓓ fusto | Ⓓ barrel |
| Ⓔ punta | Ⓔ tip |

È possibile combinare particolari di colori diversi della stessa versione (o codice), oppure abbinare elementi di versioni differenti.

You can combine differently coloured parts from the same version (or code number), or elements from different versions.

1/5

CARATTERISTICHE

- meccanismo a scatto con molla di ritorno
- realizzata in plastica ABS, atossica e ad alta resistenza
- refill Jumbo, inchiostro blu e nero
- disponibile con superfici lucide

FEATURES

- retractable with return spring
- made of non-toxic, highly resistant ABS plastic
- Jumbo refill, blue and black ink
- available in glossy finish

2/5

AREA STAMPABILE

- 1 serigrafia 35 x 36 mm
- 2 tampografia 30 x 7 mm
- 3 tampografia 48 x 10 mm

PRINT AREA

- 1 screen printing 35 x 36 mm
- 2 pad printing 30 x 7 mm
- 3 pad printing 48 x 10 mm

3/5

FUSTO, CLIP E TAPPINO

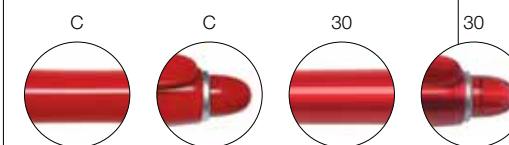

BARREL, CLIP AND PUSH-BUTTON

4/5

PUNTA E RACCORDO

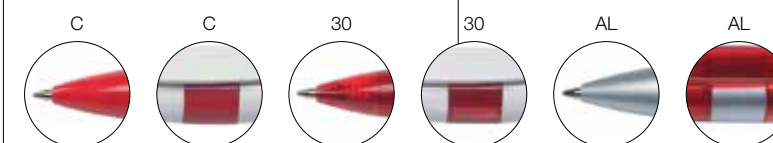

TIP AND JOINT TRIM

5/5

COLORAZIONI

- coprenti
- trasparenti



COLOURS

- solid
- transparent

Polo P600 – B

fusto, clip e tappino in colore bianco coprente,
particolari in colori coprenti, finiture lucide
solid white colour barrel, clip and push-button,
solid colours small parts, glossy finishes

**Il corpo perfettamente
cilindrico e la clip fissa,
consentono di stampare
in serigrafia a più colori.**

*The perfectly cylindrical body and fixed
clip facilitate multi-colour screen printing.*

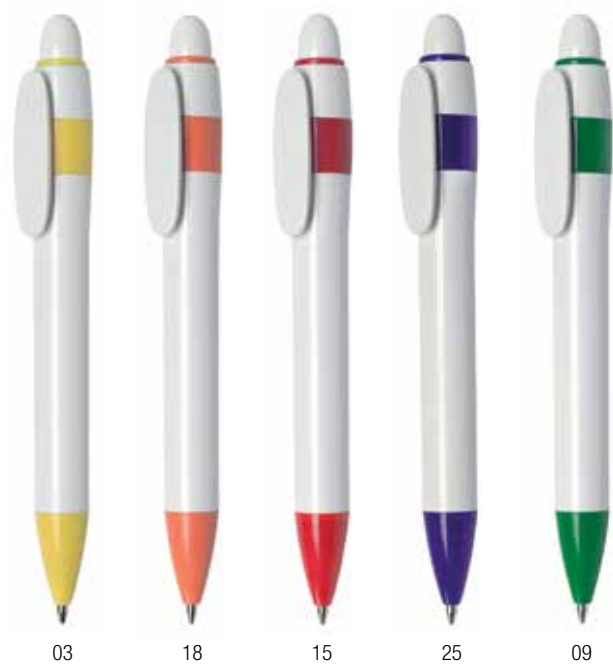

03

18

15

25

09

12 azzurro / tampografia 48 x 10 mm
12 light blue / pad printing 48 x 10 mm



04 nero / tampografia 30 x 7 mm
04 black / pad printing 30 x 7 mm

tampografia 48 x 10 mm
pad printing 48 x 10 mm



22



Polo P600 – C

colori coprenti con finitura lucida
solid colours with glossy finish



01



70 crema / tampografia 30 x 7 mm
70 cream / pad printing 30 x 7 mm



03



18 arancio / tampografia 30 x 7 mm
18 orange / pad printing 30 x 7 mm



15



09



22



04

Polo P600 – C AL

colori coprenti con finitura lucida,
particolari verniciati in colore alluminio
solid colours with glossy finish, aluminium
painted finish small parts



03 giallo / tampografia 30 x 7 mm
03 yellow / pad printing 30 x 7 mm



01



18



15



22

04 nero / tampografia 48 x 10 mm
04 black / pad printing 48 x 10 mm



Polo P600 – 30 AL

colori trasparenti con finitura lucida,
particolari verniciati in colore alluminio
transparent colours with glossy finish,
aluminium painted finish small parts

**I numerosi particolari
che compongono la penna
permettono contrasti cromatici
che la impreziosiscono.**

*The pen's numerous component parts
lend themselves to **attractive colour contrasts.***

40 grigio / tampografia 30 x 7 mm
40 grey / pad printing 30 x 7 mm



39



52



53



45



51

55 viola scuro / tampografia 30 x 7 mm
55 dark violet / pad printing 30 x 7 mm



49



44



Packaging

My case NEW

TAMPOGRAFIA / PAD PRINTING

- ① 4,2 x 16,6 cm
- ② 4,3 x 14,8 cm

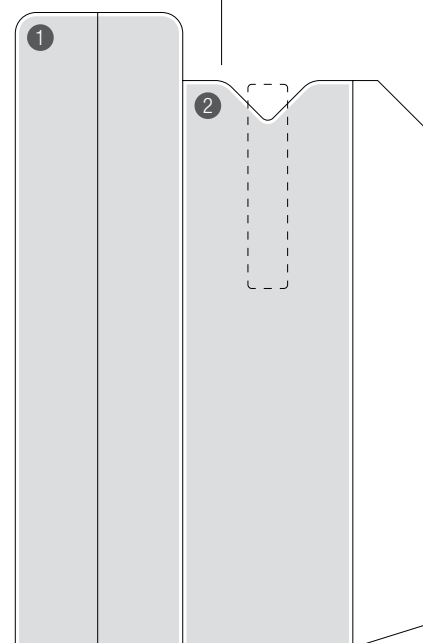

- astuccio universale per penna singola in cartoncino Fedrigoni Ultra Black 280 gr/m², personalizzabile con stampa tampografica
- dimensioni: 4,4 x 16,8 cm

- universal single pen case in Fedrigoni Ultra Black 280 g/m² card, personalisable with pad printing
- size: 4,4 x 16,8 cm

Packaging

My box NEW

TAMPOGRAFIA / PAD PRINTING

- ① 14,8 x 2 cm
- ② 14,9 x 2 cm
- ③ 14,8 x 2 cm
- ④ 14,8 x 2 cm

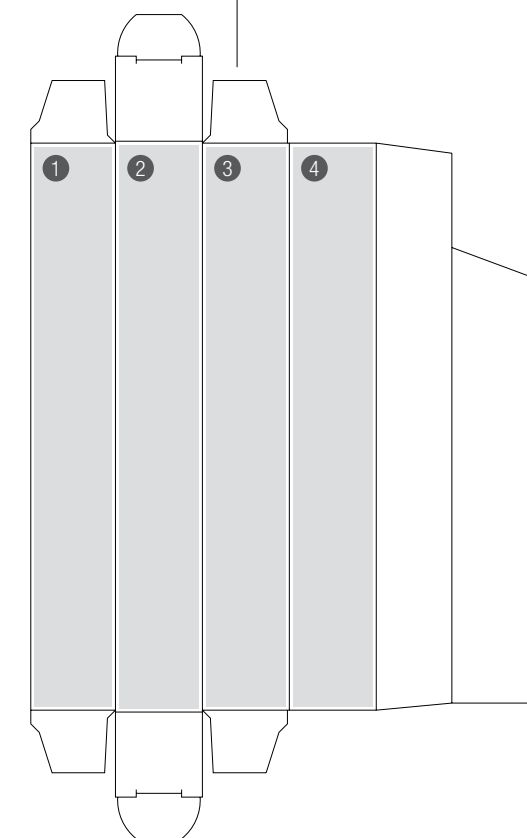

- astuccio universale richiudibile per penna singola in cartoncino Fedrigoni Ultra Black 280 gr/m², personalizzabile con stampa tampografica
- dimensioni: 2,3 x 15,1 x 2,3 cm

- universal single pen case in Fedrigoni Ultra Black 280 g/m² card, personalisable with pad printing
- size: 2,3 x 15,1 x 2,3 cm

Supporti di vendita
sales support

Color League Collection

***FOLLOW YOUR
PASSION!***



Color
League

CHOOSE YOUR COLOR

Maxema presenta la sua Color League. Partecipano tutti i colori coprenti al massimo della loro forza espressiva. Di che colore è la tua passione?

Maxema presents its Color League. All the solid colors take part at the limit of their expressive powers. What color is your passion?

Supporti di vendita

sales support

Color League Collection

NEW

Segui la tua passione e scegli il tuo colore tra i 28 della nostra Color League

Follow your passion and choose your color from the 28 of our Color League



La Color League Collection è composta da 2 Box, ciascuno contenente 14 Minikit. Ogni Minikit contiene 5 penne stampate in modelli assortiti del colore indicato in copertina.

The Colour League Collection consists of 2 Boxes, each containing 14 Minikits. Each Minikit contains 5 printed pens, in assorted models, in the colour indicated on the cover.

BOX 02



BOX 01



BOX

- Box 1: contiene 14 Minikit con i colori illustrati nell'immagine
- Box 2: contiene 14 Minikit con i colori illustrati nell'immagine
- dimensioni: 29,6 x 20 x 15,3 cm

BOXES

- Box 1: contains 14 Minikits with the colours shown in the image
- Box 2: contains 14 Minikits with the colours shown in the image
- size: 29,6 x 20 x 15,3 cm

Supporti di vendita
sales support

Color League Collection

**Per ogni colore
coprente della nostra
Palette Colori esiste
un Minikit dedicato.**

*There is a dedicated Minikit for every
solid colour in our Colour Palette.*



Supporti di vendita
sales support

Minikit

Color League Collection



MINIKIT COLOR LEAGUE

- 5 penne stampate dei modelli più rappresentativi, nel colore indicato sulla copertina del Minikit
- dimensioni: 14,7 x 19 cm (formato chiuso)

COLOR LEAGUE MINIKIT

- 5 printed pens of the most representative models in the colour suggested on the Minikit cover
- size: 14,7 x 19 cm (closed format)

Supporti di vendita
sales support

Minikit



La selezione essenziale dei nostri best seller: i Minikit sono strumenti preziosi da esporre, consultare, collezionare.

The essential selection of our best sellers: Minikits are valuable tools to display, consult and collect.



MINIKIT GENERICO

- 5 penne stampate in colori assortiti dei modelli più rappresentativi
- dimensioni: 14,7 x 19 cm (formato chiuso)

GENERAL MINIKIT

- 5 printed pens in assorted colours of the most representative models
- size: 14,7 x 19 cm (closed format)

Supporti di vendita
sales support

Kit e
raccolgitori
Kit and box sets

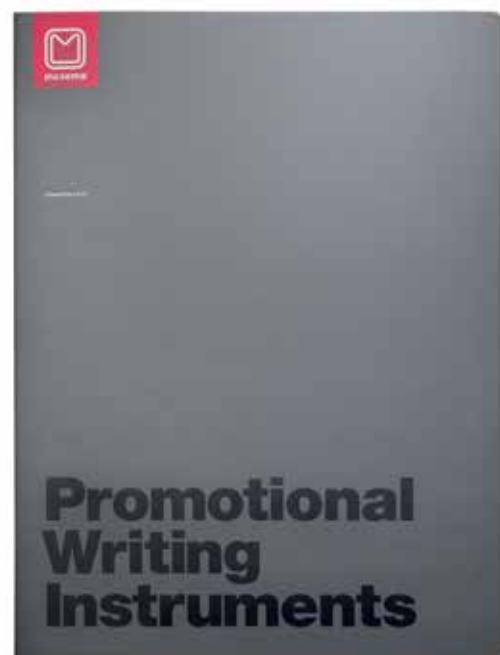

KIT

- 20 penne stampate in colori assortiti dei modelli più rappresentativi
- dimensioni: 25 x 34 cm (formato chiuso)

KIT

- 20 printed pens in assorted colours of the most representative models
- size: 25 x 34 cm (closed format)

RACCOGLITORI

- i Kit sono disponibili in raccoglitori da 1, 2 o 3

- 1 28 x 33 x 3 cm
- 2 28 x 33 x 5,5 cm
- 3 28 x 33 x 8 cm

BOX SETS

- the Kits are available in 1, 2 or 3 unit box sets

- 1 28 x 33 x 3 cm
- 2 28 x 33 x 5,5 cm
- 3 28 x 33 x 8 cm



KIT MODELLO

- 20 penne stampate in colori assortiti di un unico modello
- dimensioni: 25 x 34 cm (formato chiuso)
- il Kit Modello è disponibile per: Flow Pure, Flow, Dot, Zink, View, Tag, Icon, Icon Green, Tag Green, Ethic, Pixel, Next, Bay.

MODEL KIT

- 20 printed pens in assorted colours of a single model
- size: 25 x 34 cm (closed format)
- the Model Kit is available for: Flow Pure, Flow, Dot, Zink, View, Tag, Icon, Icon Green, Tag Green, Ethic, Pixel, Next.

Su richiesta si possono realizzare campionari personalizzati con penne di specifiche versioni e colori.

On request we can prepare customised sets of samples containing specific versions and colours of pens.

Palette colori

colour palette

coprenti / solid

01 bianco white	70 crema cream	03 giallo yellow	18 arancio orange	15 rosso red	74 bordeaux burgundy
60 rosa pink	61 magenta magenta	71 viola chiaro light violet	25 viola scuro dark violet	72 cuoio leather	73 marrone brown
79 lime lime	09 verde green	75 verde scuro dark green	26 acquamarina aquamarine	27 ottanio octan green	64 azzurro pastello pastel blue
77 ciano cyan	12 azzurro light blue	22 blu blue	05 grigio grey	04 nero black	

trasparenti / transparent

39 neutro neutral	52 giallo yellow	53 arancio orange	45 rosso red	59 rosa pink	41 magenta magenta
31 lilla lilac	51 viola violet	55 viola scuro dark violet	37 ambra amber	38 marrone brown	78 lime lime
49 verde green	47 acquamarina aquamarine	34 azzurro light blue	67 ciano cyan	44 blu blue	30 grigio chiaro light grey
40 grigio grey	50 grigio scuro dark grey				

Icon green e Tag green coprenti / solid Icon green and Tag green

01 bianco white	70 crema cream	42 giallo yellow	43 arancio orange	35 rosso red	13 marrone brown
29 verde green	65 verde scuro dark green	77 ciano cyan	54 blu blue	04 nero black	

vernici metallizzate / metallic paintings

91 perla pearl	92 oro gold	83 rame copper	85 rosso red	81 viola violet	82 viola scuro dark violet
89 verde green	94 avio aviation	95 blu blue	96 antracite anthracite	alluminio aluminium	

fluo coprenti / solid fluo

02 giallo yellow	17 arancio orange	14 rosso corallo coral red	56 fucsia fuchsia	08 verde green
------------------	-------------------	----------------------------	-------------------	----------------

fluo trasparenti / transparent fluo

20 giallo yellow	33 arancio orange	24 rosso corallo coral red	46 fucsia fuchsia	48 verde green
------------------	-------------------	----------------------------	-------------------	----------------

trattamento galvanico / galvanic process

● cromato chrome	● dorato gold
------------------	---------------

Codici pantone

pantone codes

In questa tabella sono riportati i nostri colori con i codici Pantone che più si avvicinano a quelli della nostra Palette. La corrispondenza è puramente indicativa.

Our colour chart is shown below with the Pantone codes closest to those of our Palette. Matches are approximate.

coprenti / solid

01 bianco	70 crema /cream	03 giallo /yellow	18 arancio / orange	15 rosso / red	74 bordeaux / burgundy
60 rosa / pink	61 magenta / magenta	71 viola chiaro / light violet	25 viola scuro / dark violet	72 cuoio / leather	73 marrone / brown
79 lime / lime	09 verde / green	75 verde scuro / dark green	26 acquamarina / aquamarine	27 ottanio / octan green	64 azzurro pastello / pastel blue
77 ciano / cyan	12 azzurro / light blue	22 blu / blue	05 grigio / grey	04 nero / black	

pant 7499
pant 120
pant 1505
pant 187
pant 195
pant 1905
pant 213
pant 270
pant violet
pant 7571
pant 7582
pant 381
pant 348
pant 3435
pant 3262
pant 321
pant 283
pant 2995
pant 285
pant 287
pant cool gray 6
pant black 6

trasparenti / transparent

39 neutro / neutral	39 neutro / neutral
52 giallo / yellow	52 giallo / yellow
53 arancio / orange	53 arancio / orange
45 rosso / red	45 rosso / red
59 rosa / pink	59 rosa / pink
41 magenta	41 magenta
31 lilla / lilac	31 lilla / lilac
51 viola / violet	51 viola / violet
55 viola scuro / dark violet	55 viola scuro / dark violet
37 ambra / amber	37 ambra / amber
38 marrone / brown	38 marrone / brown
78 lime / lime	78 lime / lime
49 verde / green	49 verde / green
47 acquamarina / aquamarine	47 acquamarina / aquamarine
34 azzurro / light blue	34 azzurro / light blue
67 ciano / cyan	67 ciano / cyan
44 blu / blue	44 blu / blue
30 grigio chiaro / light grey	30 grigio chiaro / light grey
40 grigio / grey	40 grigio / grey
50 grigio scuro / dark grey	50 grigio scuro / dark grey

pant 116
pant 1505
pant 200
pant 1905
pant 213
pant 2705
pant 2425
pant violet
pant 7571
pant 7582
pant 381
pant 348
pant 3435
pant 3262
pant 321
pant 283
pant 2995
pant 285
pant 287
pant cool gray 6
pant 437
pant 446

Icon green e Tag green coprenti / solid Icon green and Tag green

01 bianco / white	70 crema /cream	42 giallo / yellow	43 arancio / orange	35 rosso /red	13 marrone / brown
29 verde / green	65 verde scuro / dark green	77 ciano / cyan	54 blu / blue	04 nero / black	

pant 7499
pant 012
pant 151
pant 179
pant 7532
pant 7741
pant 343
pant 2995
pant 7685
pant black 6

I colori Pantone sono disponibili su richiesta, contattateci per conoscere i quantitativi minimi per ogni modello.

Pantone colours are available on demand. Please contact us to find out the minimum order quantity for each model.

Inchiostri e refill

inks and refills

X-20



lunghezza 107 mm, fino a 2000 metri di scrittura
length 107 mm, for up to 2000 meters of writing

jumbo



lunghezza 107 mm, fino a 2500 metri di scrittura
length 107 mm, for up to 2500 meters of writing

RT 90 su richiesta / on demand



sfera in acciaio inox Ø 1 mm, lunghezza 98 mm, fino a 4000 metri di scrittura
ball stainless steel Ø 1 mm, length 98 mm, for up to 4000 meters of writing

RT 90 su richiesta / on demand



sfera in acciaio inox Ø 0,8 mm, lunghezza 98 mm, fino a 4000 metri di scrittura
ball stainless steel Ø 0,8 mm, length 98 mm, for up to 4000 meters of writing

inchiostri / inks



blu
blue



nero
black

tutti i diritti riservati maxema srl
all rights reserved maxema srl

I marchi menzionati in questo catalogo sono di proprietà esclusiva dei rispettivi proprietari. L'utilizzo dei suddetti marchi è a puro titolo esemplificativo e non potrà mai, in alcun caso, essere oggetto di trattative commerciali.

The brands mentioned in this catalogue are the exclusive property of the respective owners. They are used for purely illustrative purposes and cannot be the object of any buying and selling transactions, under any circumstances.

Il tubetto del refill è in polipropilene, la punta è in ottone nichelato e la sfera in acciaio inox Ø 1 mm. L'inchiostro, atossico, è Dokumental.

The refill's barrel is made of polypropilene, the tip is made of nickel-plated brass and the ball stainless steel Ø 1 mm. The non-toxic ink is Dokumental.

Tutti gli inchiostri Dokumental sono conformi alla normativa europea REACH e americana TSCA.

All Dokumental inks comply with European REACH and American TSCA standards.

art direction and graphic design
undesign.it

still life
infiniostudio.com

editing
elena ambrosio
sara zampedri

MADE IN ITALY

PRODOTTO IN ITALIA

FABRIQUE EN ITALIE

FABBRICADO EN ITALIA

